

ASME B16.10-2017
(Revision of ASME B16.10-2009)

Face-to-Face and End-to-End Dimensions of Valves

AN AMERICAN NATIONAL STANDARD



The American Society of
Mechanical Engineers

ASME B16.10-2017
(Revision of ASME B16.10-2009)

Face-to-Face and End-to-End Dimensions of Valves

AN AMERICAN NATIONAL STANDARD



**The American Society of
Mechanical Engineers**

Two Park Avenue • New York, NY • 10016 USA

Date of Issuance: June 2, 2017

The next edition of this Standard is scheduled for publication in 2021.

ASME issues written replies to inquiries concerning interpretations of technical aspects of this Standard. Periodically certain actions of the ASME B16 Committee may be published as Cases. Cases and interpretations are published on the ASME Web site under the Committee Pages at <http://cstools.asme.org/> as they are issued.

Errata to codes and standards may be posted on the ASME Web site under the Committee Pages to provide corrections to incorrectly published items, or to correct typographical or grammatical errors in codes and standards. Such errata shall be used on the date posted.

The Committee Pages can be found at <http://cstools.asme.org/>. There is an option available to automatically receive an e-mail notification when errata are posted to a particular code or standard. This option can be found on the appropriate Committee Page after selecting “Errata” in the “Publication Information” section.

ASME is the registered trademark of The American Society of Mechanical Engineers.

This code or standard was developed under procedures accredited as meeting the criteria for American National Standards. The Standards Committee that approved the code or standard was balanced to assure that individuals from competent and concerned interests have had an opportunity to participate. The proposed code or standard was made available for public review and comment that provides an opportunity for additional public input from industry, academia, regulatory agencies, and the public-at-large.

ASME does not “approve,” “rate,” or “endorse” any item, construction, proprietary device, or activity.

ASME does not take any position with respect to the validity of any patent rights asserted in connection with any items mentioned in this document, and does not undertake to insure anyone utilizing a standard against liability for infringement of any applicable letters patent, nor assume any such liability. Users of a code or standard are expressly advised that determination of the validity of any such patent rights, and the risk of infringement of such rights, is entirely their own responsibility.

Participation by federal agency representative(s) or person(s) affiliated with industry is not to be interpreted as government or industry endorsement of this code or standard.

ASME accepts responsibility for only those interpretations of this document issued in accordance with the established ASME procedures and policies, which precludes the issuance of interpretations by individuals.

No part of this document may be reproduced in any form,
in an electronic retrieval system or otherwise,
without the prior written permission of the publisher.

The American Society of Mechanical Engineers
Two Park Avenue, New York, NY 10016-5990

Copyright © 2017 by
THE AMERICAN SOCIETY OF MECHANICAL ENGINEERS
All rights reserved
Printed in U.S.A.

CONTENTS

Foreword	iv
Committee Roster	vi
Correspondence With the B16 Committee	vii
1 Scope	1
2 Definitions	2
3 Facings of Flanged Valves	3
4 Variations of Length Within a Class of Valves	3
5 Tolerances	3
Figures	
1 Flange Facings and Their Relationships	5
2 Welding Ends	6
Tables	
1 Class 125 Cast Iron Flanged and Class 150 Steel Flanged and Buttwelding End Valves, Face-to-Face and End-to-End Dimensions	7
2 Class 250 Cast Iron Flanged and Class 300 Steel Flanged and Buttwelding End Valves, Face-to-Face and End-to-End Dimensions	12
3 Class 600 Steel Flanged and Buttwelding End Valves, Face-to-Face and End-to-End Dimensions	15
4 Class 900 Steel Flanged and Buttwelding End Valves, Face-to-Face and End-to-End Dimensions	17
5 Class 1500 Steel Flanged and Buttwelding End Valves, Face-to-Face and End-to-End Dimensions	19
6 Class 2500 Steel Flanged and Buttwelding End Valves, Face-to-Face and End-to-End Dimensions	21
7 Classes 125 and 250 Cast Iron and Classes 150 to 2500 Steel Wafer Type Valves, Face-to-Face Dimensions	22
8 Classes 25 and 125 Cast Iron and Classes 150 to 600 Steel Butterfly Valves, Face-to-Face Dimensions	23
9 Determination of Face-to-Face and End-to-End Dimensions of Flanged Valves Having Various Flange Facings	24
10 Classes 150 to 2500 Steel Valves Having End Flanges With Ring Joint Facings, End-to-End Dimensions	25
Mandatory Appendix	
I Face-to-Face and End-to-End Dimensions: U.S. Customary Units	27
Nonmandatory Appendix	
A References	47

FOREWORD

In 1921, the American Engineering Standards Committee, later the American Standards Association (ASA), organized Sectional Committee B16 to unify and further develop national standards for pipe flanges and fittings (and, later, for valves, gaskets, and valve actuators). Cosponsors of the B16 Committee were The American Society of Mechanical Engineers (ASME), the Heating and Piping Contractors National Association [now the Mechanical Contractors Association of America (MCAA)], and the Manufacturers Standardization Society of the Valve and Fittings Industry (MSS). Cosponsors were later designated as cosecretariat organizations.

Pioneer work on standardization of end-to-end dimensions of valves began in 1917 under the direction of J. A. Stevens. It was put aside at the end of World War I and interest did not revive until 1926. ASA and ASME agreed to include the topic in the scope of the B16 Committee, and Subcommittee 5 (now Subcommittee E) was established for the purpose. Work began in 1928 and covered ferrous flanged-end gate, globe, angle, and check valves.

Development of a national standard was hindered by the diversity of existing practices and by adverse economic conditions in the early 1930s. A proposed 1933 American Standard for face-to-face dimensions of ferrous flanged valves did not gain acceptance, even though it was largely based on a 1931 Standard Practice of MSS. Further work and industry developments led to a meeting in May 1937, which undertook to reconcile differences among the draft ASA standard, two American Petroleum Institute (API) standards (5-G-1 on pipeline valves and 600A on flanged OS&Y steel wedge gate valves), and a newly updated MSS SP-32.

A revised B16 proposal was voted favorably in June 1938, was approved by ASA, and was published in 1939. The standard was reaffirmed in 1947. Work began on a revision in 1953 to include butt welding end valves, plug valves, and control valves in both cast iron and steel. That edition was published as ASA B16.10-1957. Further revision was begun in 1964. After reorganization of ASA, first as the United States of America Standards Institute (USASI), then as American National Standards Institute (ANSI), with the Sectional Committee being redesignated as an American National Standards Committee, a new edition adding ball valves was approved and published as ANSI B16.10-1973.

In 1982, American National Standards Committee B16 was reorganized as an ASME Committee operating under procedures accredited by ANSI. In the 1986 Edition, ductile iron and the alloys covered by ANSI B16.34 were added to the materials covered. Wafer type gate and check valves, Class 150 Y-pattern globe and check valves, and several patterns of butterfly valves were added to the types covered. Inch dimensions were converted from common to two-place decimal fractions.

In 1991, Subcommittee E — Face-to-Face and End-to-End Dimensions of Valves, was combined with Subcommittee N — Steel Valves. In the 1992 Edition, steel offset seat and grooved end butterfly valves were added. Globe and flangeless style control valves, which previously had been included, were removed from the Standard. Information regarding control valve dimensions may be obtained from The International Society of Automation (ISA), 67 T. W. Alexander Drive, Research Triangle Park, NC 27709.

In the 2000 Edition, metric dimension tables were added. All tables and references to Class 400 steel and Class 800 cast iron were removed. All tables were renumbered. Following the approvals of the Standards Committee and ASME, approval for the edition was granted by ANSI on June 7, 2000.

In the 2009 Edition, Nonmandatory Appendix A was revised and updated. Also, all affected regions of the Standard were updated to reflect the changes in Nonmandatory Appendix A. PN values and references to API 605 were removed from the Standard. Following approval by the B16 Standards Committee and the ASME Supervisory Board, the Standard was approved as an American National Standard by ANSI on June 15, 2009.

In this 2017 Edition, tolerances for straightway valves were modified and new NPS sizes have been added. Singular Face-to-Face dimensions for Class 150 and Class 300 valves, and short and long pattern face-to-face dimensions have been added to Tables 7 and I-7. Following approval by the B16 Standards Committee, this Standard was approved as an American National Standard by ANSI on April 25, 2017.

ASME B16 COMMITTEE

Standardization of Valves, Flanges, Fittings, and Gaskets

(The following is the roster of the Committee at the time of approval of this Standard.)

STANDARDS COMMITTEE OFFICERS

R. Bojarczuk, *Chair*
C. E. Davila, *Vice Chair*
C. O'Brien, *Secretary*

STANDARDS COMMITTEE PERSONNEL

A. Appleton , Alloy Stainless Products Co., Inc.	G. Jolly , Samshin Ltd.
R. Barnes , Anric Enterprises, Inc.	M. Katcher , Haynes International
K. Barron , Ward Manufacturing	T. A. McMahon , Emerson Process Management
W. Bedesem , Consultant	M. L. Nayyar , NICE
R. Bojarczuk , ExxonMobil Research and Engineering Co.	C. O'Brien , The American Society of Mechanical Engineers
A. M. Cheta , Qatar Shell GTL	W. H. Patrick , The Dow Chemical Co.
M. Clark , NIBCO, Inc.	D. Raho , CCM 2000
G. A. Cuccio , Capitol Manufacturing Co.	R. A. Schmidt , Canadoil
C. Davila , Crane Energy	H. R. Sonderegger , Fluoroseal Valves USA
D. Frikken , Becht Engineering Co.	W. M. Stephan , Flexitallic LP
R. B. Hai , RBH Associates	F. R. Volgstadt , Volgstadt & Associates, Inc.
K. A. Hettler , U.S. Coast Guard	D. A. Williams , Southern Company Generation
	F. Feng , <i>Delegate</i> , China Productivity Center for Machinery

SUBCOMMITTEE N — STEEL VALVES AND FACE-TO-FACE AND END-TO-END DIMENSIONS OF VALVES

T. A. McMahon , <i>Chair</i> , Emerson Process Management	R. B. Hai , RBH Associates
G. Jolly , <i>Vice Chair</i> , Samshin Ltd.	P. W. Heald , Bonney Forge
R. Lucas , <i>Secretary</i> , The American Society of Mechanical Engineers	J. R. Holstrom , Val-Matic Valve & Manufacturing Corp.
R. Barnes , Anric Enterprises, Inc.	M. Katcher , Haynes International
W. Bedesem , Consultant	T. N. Macdonald , Sargent & Lundy
R. A. Benjamin , Newport News Shipbuilding	M. Nayyar , NICE
R. Bojarczuk , ExxonMobil Research and Engineering Co.	W. H. Patrick , The Dow Chemical Co.
T. R. Brooks , Consultant	D. Raho , CCM 2000
A. M. Cheta , Qatar Shell GTL	K. Reid II , Parker Hannifin
C. Davila , Crane Energy	H. R. Sonderegger , Fluoroseal Valves USA
S. DuChez , Bechtel	C. Sumner , Conval, Inc.
R. T. Faircloth , Cameron	D. E. Tezzo , Pentair Valves & Controls
D. Frikken , Becht Engineering Co.	J. Tucker , Flowserve
E. Gulgun , International StandardValve, Inc.	M. M. Zaidi , Jacobs Engineering

CORRESPONDENCE WITH THE B16 COMMITTEE

General. ASME Standards are developed and maintained with the intent to represent the consensus of concerned interests. As such, users of this Standard may interact with the Committee by requesting interpretations, proposing revisions or a case, and attending Committee meetings. Correspondence should be addressed to:

Secretary, B16 Standards Committee
The American Society of Mechanical Engineers
Two Park Avenue
New York, NY 10016-5990
<http://go.asme.org/Inquiry>

Proposing Revisions. Revisions are made periodically to the Standard to incorporate changes that appear necessary or desirable, as demonstrated by the experience gained from the application of the Standard. Approved revisions will be published periodically.

The Committee welcomes proposals for revisions to this Standard. Such proposals should be as specific as possible, citing the paragraph number(s), the proposed wording, and a detailed description of the reasons for the proposal, including any pertinent documentation.

Proposing a Case. Cases may be issued to provide alternative rules when justified, to permit early implementation of an approved revision when the need is urgent, or to provide rules not covered by existing provisions. Cases are effective immediately upon ASME approval and shall be posted on the ASME Committee Web page.

Requests for Cases shall provide a Statement of Need and Background Information. The request should identify the Standard and the paragraph, figure, or table number(s), and be written as a Question and Reply in the same format as existing Cases. Requests for Cases should also indicate the applicable edition(s) of the Standard to which the proposed Case applies.

Interpretations. Upon request, the B16 Standards Committee will render an interpretation of any requirement of the Standard. Interpretations can only be rendered in response to a written request sent to the Secretary of the B16 Standards Committee.

Requests for interpretation should preferably be submitted through the online Interpretation Submittal Form. The form is accessible at <http://go.asme.org/InterpretationRequest>. Upon submittal of the form, the Inquirer will receive an automatic e-mail confirming receipt.

If the Inquirer is unable to use the online form, he/she may e-mail the request to the Secretary of the B16 Standards Committee at SecretaryB16@asme.org, or mail it to the above address. The request for an interpretation should be clear and unambiguous. It is further recommended that the Inquirer submit his/her request in the following format:

Subject:	Cite the applicable paragraph number(s) and the topic of the inquiry in one or two words.
Edition:	Cite the applicable edition of the Standard for which the interpretation is being requested.
Question:	Phrase the question as a request for an interpretation of a specific requirement suitable for general understanding and use, not as a request for an approval of a proprietary design or situation. Please provide a condensed and precise question, composed in such a way that a "yes" or "no" reply is acceptable.
Proposed Reply(ies):	Provide a proposed reply(ies) in the form of "Yes" or "No," with explanation as needed. If entering replies to more than one question, please number the questions and replies.
Background Information:	Provide the Committee with any background information that will assist the Committee in understanding the inquiry. The Inquirer may also include any plans or drawings that are necessary to explain the question; however, they should not contain proprietary names or information.

Requests that are not in the format described above may be rewritten in the appropriate format by the Committee prior to being answered, which may inadvertently change the intent of the original request.

ASME procedures provide for reconsideration of any interpretation when or if additional information that might affect an interpretation is available. Further, persons aggrieved by an interpretation may appeal to the cognizant ASME Committee or Subcommittee. ASME does not “approve,” “certify,” “rate,” or “endorse” any item, construction, proprietary device, or activity.

Attending Committee Meetings. The B16 Standards Committee regularly holds meetings and/or telephone conferences that are open to the public. Persons wishing to attend any meeting and/or telephone conference should contact the Secretary of the B16 Standards Committee.

FACE-TO-FACE AND END-TO-END DIMENSIONS OF VALVES

1 SCOPE

1.1 General

1.1.1 Application. This Standard covers face-to-face and end-to-end dimensions of straightway valves, and center-to-face and center-to-end dimensions of angle valves. Its purpose is to ensure installation interchangeability for valves of a given material, type, size, rating class, and end connection. Face-to-face and center-to-face dimensions apply to flanged end valves with facings defined in para. 2.3.1 and to other valves intended for assembly between flat face or raised face flanges. End-to-end dimensions apply to grooved end, buttwelding end, and flanged end valves with facings defined in para. 2.3.3. Center-to-end dimensions apply to buttwelding end and to flanged end valves with facings defined in para. 2.3.3.

1.1.2 Data Source Reference. Throughout this Standard, data references are cited, e.g., “extracted from” and “compatible with.” These data are relevant to the reference standard in place at the date shown in the Foreword for American National Standards Institute approval of this Standard.

1.2 Standard Units

This Standard states values in both SI (Metric) and U.S. Customary units. These systems of units are to be regarded separately as standard. Within the text, the U.S. Customary units are shown in parentheses or in separate tables that appear in Mandatory Appendix I. The values stated in each system are not exact equivalents; therefore, it is required that each system of units be used independently of the other. Combining values from the two systems constitutes nonconformance with the Standard.

1.3 Cast Iron Valves

Only flanged end valves (and others intended for assembly between flanges) are covered by this Standard. Mating dimensions and facings of flanged ends conform to those in ASME B16.1. Dimensional tables for various types and sizes of valves are specified in paras. 1.3.1 through 1.3.4.

1.3.1 Gate, Plug, and Check Valves

- (a) Class 125 — Tables 1 and I-1
- (b) Class 250 — Tables 2 and I-2

1.3.2 Globe and Angle Valves

- (a) Class 125 — Tables 1 and I-1
- (b) Class 250 — Tables 2 and I-2

1.3.3 Wafer Swing Check Valves

- (a) Class 125 — Tables 7 and I-7
- (b) Class 250 — Tables 7 and I-7

1.3.4 Butterfly Valves

- (a) Class 25 — Tables 8 and I-8
- (b) Class 125 — Tables 8 and I-8

1.4 Ductile Iron Valves

Only flanged end valves (and others intended for assembly between flanges) are covered. Mating dimensions and facings of flanged ends conform to those in ASME B16.42. Valves are rated Class 150 and Class 300. The following cast iron and steel dimensional tables are also used for ductile valves:

- (a) Class 150 — Tables 1 and I-1
- (b) Class 300 — Tables 2 and I-2

1.5 Steel and Alloy Valves

This category includes carbon, alloy, and stainless steels, and the nonferrous materials listed in ASME B16.34. It includes flanged, buttwelding, and grooved ends, as well as the types of valves intended for assembly between flanges. Mating dimensions and facings of flanged ends conform to those in ASME B16.5, ASME B16.47, Series A, or MSS SP-44. [For flanged end butterfly valves, refer to Note (2) of Table 8 (Table I-8) for flange information.] For flangeless or wafer valves intended for assembly between flanges, refer to Tables 7 and 8 (Tables I-7 and I-8) for flange information. Only buttwelding end valves in rating Classes 150 through 2500 are included in this Standard. Dimensional tables for various types and sizes of valves are specified in paras. 1.5.1 through 1.5.5.

1.5.1 Gate, Globe, Angle, Check, Plug, and Ball Valves

- (a) Class 150 — Tables 1 and I-1
- (b) Class 300 — Tables 2 and I-2
- (c) Class 600 — Tables 3 and I-3
- (d) Class 900 — Tables 4 and I-4
- (e) Class 1500 — Tables 5 and I-5
- (f) Class 2500 — Tables 6 and I-6

1.5.2 Y-Pattern Globe and Y-Pattern Swing Check Valves

Class 150 — Tables 1 and I-1

1.5.3 Wafer Knife Gate Valves

- (a) Class 150 — Tables 7 and I-7
(b) Class 300 — Tables 7 and I-7

1.5.4 Wafer Swing Check Valves

Class 150 to 2500 — Tables 7 and I-7

1.5.5 Butterfly Valves

- (a) Class 150 — Tables 8 and I-8
(b) Class 300 — Tables 8 and I-8
(c) Class 600 — Tables 8 and I-8

1.6 Convention

For determining conformance with this Standard, the convention for fixing significant digits where limits (maximum and minimum values) are specified shall be as defined in ASTM E29. This requires that an observed or calculated value be rounded off to the nearest unit in the last right-hand digit used for expressing the limit. Decimal values and tolerances do not imply a particular method of measurement.

2 DEFINITIONS

2.1 Valve Size Designation

2.1.1 Nominal Diameter (DN). The size of a valve is designated by the nominal size of its end connections. This is denoted by (DN), a dimensionless number indirectly related to the physical size of the connecting pipe [See Tables 1 through 10 (Tables I-1 through I-10)]. The valve size is not necessarily the same as the inside diameter or port diameter.

2.1.2 Valve Size Designation. NPS, followed by a dimensionless number, is the designation for nominal valve size. NPS is related to the reference *nominal diameters*, DN, used in international standards. The relationship is, typically, as follows:

NPS	DN
1/4	8
3/8	10
1/2	15
3/4	20
1	25
1 1/4	32
1 1/2	40
2	50
2 1/2	65
3	80
4	100

GENERAL NOTE: For NPS ≥ 4 , the related DN = 25 multiplied by the NPS number.

2.1.3 Reduced Port Valves

(a) Reduced port, gate, and ball valves conforming to API 6D are designated for size by two numbers, the first being the NPS on the valve ends, the second being the NPS of the port (seats, moving parts, etc.); e.g., NPS 6 \times 4 designates a valve of end size NPS 6 with a port to match NPS 4. These valves shall have face-to-face or end-to-end dimensions corresponding to valves having the same size end connections; i.e., a NPS 6 \times 4 valve shall have the face-to-face or end-to-end dimensions of a NPS 6 valve.

(b) Reduced port, pressure seal bonnet, gate, globe, and check valves are designated for size by three numbers, the first and last being the NPS of the valve ends, the second being the NPS of the port; e.g., NPS 6 \times 4 \times 6 designates a valve having ends matching NPS 6 with a port to match NPS 4. Likewise, NPS 6 \times 4 \times 4 would designate a valve having one end matching NPS 6, the other matching NPS 4, and the port matching NPS 4. These valves shall have face-to-face or end-to-end dimensions corresponding to valves having the same port size; i.e., either a NPS 6 \times 4 \times 6 or a NPS 6 \times 4 \times 4 valve shall have the face-to-face or end-to-end dimensions of a NPS 4 valve.

2.2 Pressure Rating Designations

Class, followed by a dimensionless number, is the standardized designation for pressure temperature-ratings used for valves. The numerical designations in use are as follows:

- (a) for cast iron: 25, 125, 250
(b) for ductile iron: 150, 300
(c) for steel:¹ 150, 300, 600, 900, 1500, 2500

2.3 Flanged Valve Dimensions

2.3.1 Face-to-Face. The face-to-face dimension for flanged valves is the distance between the extreme ends which are the gasket contact surfaces (see Fig. 1). Face-to-face applies to flanged valves having the following nominal flange facing identifiers:

- (a) flat
(b) 2 mm (0.06 in.) raised
(c) 7 mm (0.25 in.) raised
(d) large or small male²
(e) large or small tongue²

2.3.2 Installed Face-to-Face. The installed face-to-face dimension of certain butterfly valves [see Table 8 (Table I-8), Note (6)] may include allowances for gasket or resilient-facing compression. Refer to MSS SP-67 for definitive illustrations.

2.3.3 End-to-End. For those flanged valves where the gasket contact surfaces are not located at the extreme

¹ Includes all ferrous and nonferrous materials in ASME B16.34.

² Face-to-face dimensions in Tables 1 through 6 (Tables I-1 through I-6) must be adjusted as indicated in Table 9 (Table I-9).

ends of the valve, the distance between the extreme ends is described as the end-to-end dimension and applies to flanged valves having the following nominal flange facing identifiers:

- (a) ring joint
- (b) large or small female
- (c) large or small groove

2.4 Buttwelding End Valve Dimensions

For buttwelding end valves, the end-to-end dimension is the distance between the extreme ends (root faces) of the welding bevels (see Fig. 2).

Also see section 4.

2.5 Grooved End Valve Dimensions

The end-to-end dimension for grooved end valves is the distance between extreme ends.

2.6 Angle Valves

For flanged angle type valves (those in which the ends are at an angle of 90 deg to each other), the center-to-face dimension is the distance from the centerline of the port to the extreme end which is the gasket contact surface. For flanged angle type valves in which the gasket seating surface is not located at the extreme end and for angle type valves having buttwelding ends, the phrase center-to-end denotes the distance from the centerline of the port to the extreme end.

3 FACINGS OF FLANGED VALVES

Figure 1 shows facings for flanged ends.

3.1 Facings Normally Furnished

3.1.1 Flat Face. Flanges for Classes 25 and 125 cast iron valves are flat faced.

3.1.2 2 mm (0.06 in.) Raised Face. Flanges for Class 250 cast iron and for Classes 150 and 300 steel, alloy, and ductile iron valves have 2 mm (0.06 in.) raised faces, which are included in the face-to-face (or center-to-face) dimension. When Classes 150 and 300 valves are required with flat faces, either the full thickness of flange or the thickness with the 2 mm (0.06 in.) raised face removed may be furnished, unless otherwise specified by the customer. Users are reminded that removing the 2 mm (0.06 in.) raised face will make the face-to-face dimension nonstandard.

3.1.3 7 mm (0.25 in.) Raised Face. Flanges for Class 600 and higher steel and alloy valves have 7 mm (0.25 in.) raised faces, which are included in the face-to-face (or center-to-face) dimensions.

3.2 Other Standard Facings

Table 9 (Table I-9) summarizes data on all flange facings and can be used with Tables 1 through 6

(Tables I-1 through I-6) in calculating face-to-face and end-to-end dimensions of flanged valves having standard facings other than those described in para. 3.1.

3.3 Ring Joint Facings

The X dimension given in Table 10 (Table I-10), when added to the face-to-face dimension of a valve having raised face flanges in Tables 1 through 6 (Tables I-1 through I-6), establishes the end-to-end dimension for the valve having flanges with ring joint facings.

4 VARIATIONS OF LENGTH WITHIN A CLASS OF VALVES

4.1 Buttwelding End Valves

Tables 1 through 6 (Tables I-1 through I-6) include end-to-end dimensions for valves having buttwelding ends. In many cases, the dimensions are different from those of face-to-face dimensions of flanged valves, as evidenced by the differences between dimensions A and B of the tables.

Also see para. 2.4.

4.1.1 Short Pattern. For pressure seal or flangeless bonnet valves having buttwelding ends in Class 600 and higher, the regular end-to-end dimensions shall be equal to the short pattern dimensions shown in Tables 3 through 6 (Tables I-3 through I-6). At the manufacturer's option, the end-to-end dimensions of these valves may be the same as the face-to-face dimensions of raised face flanged valves.

4.1.2 Long Pattern. For flanged bonnet valves having buttwelding ends in Class 600 and higher, the regular end-to-end dimensions shall be equal to the face-to-face dimensions of raised face flanged valves shown in Tables 3 through 6 (Tables I-3 through I-6). At the manufacturer's option, the end-to-end dimensions may be the same as the short pattern end-to-end dimensions.

4.2 Narrow, Wide, and Extra Wide Designations

Certain butterfly valves are designated narrow, wide, or extra wide for the purpose of consolidating a diversity of manufacturer's lengths into two or three sets of dimensions for a given size. At the manufacturer's option, any of the two or three dimensions listed for a size may be used.

5 TOLERANCES

5.1 Straightway Valves

A tolerance of ± 1.5 mm (± 0.06 in.) shall be allowed on face-to-face and end-to-end dimensions of valves of NPS 10 and smaller, and a tolerance of ± 3.0 mm (± 0.12 in.) shall be allowed for NPS 12 and larger. For exceptions as related to wafer type and butterfly valves,

see General Note (b) in Table 7 (Table I-7) and Notes (3) and (4) in Table 8 (Table I-8).

5.2 Angle Valves

The tolerances on center-to-face and center-to-end dimensions of angle type valves shall be one-half those listed in para. 5.1.

Fig. 1 Flange Facings and Their Relationships

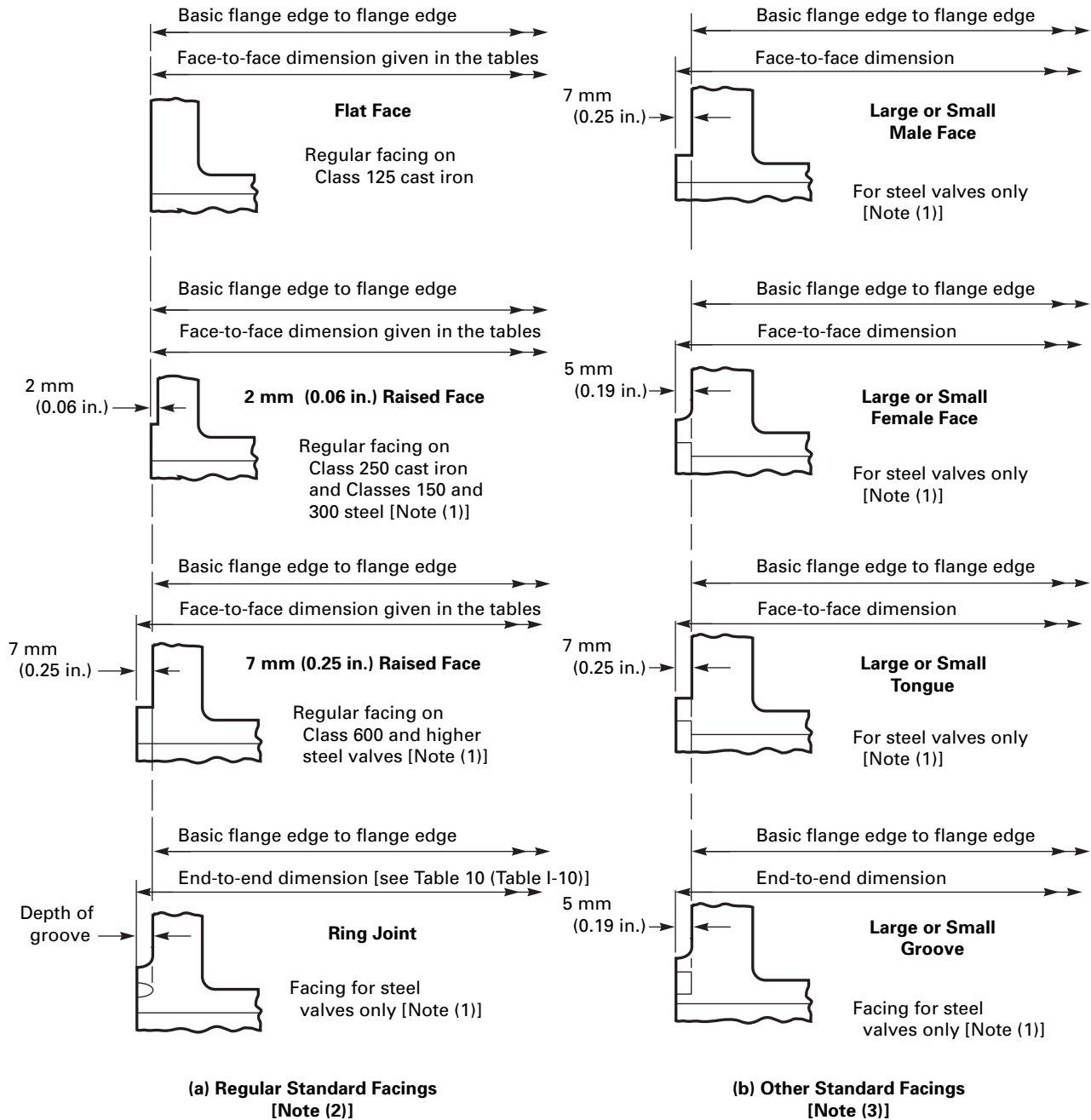

NOTES:

- (1) Steel includes nonferrous materials in ASME B16.34.
- (2) Regular flange facings for valves are shown above. Valves normally carried in stock are so faced.
- (3) Valves are supplied with the facings shown above when specified. See Table 9 (Table I-9) to determine face-to-face dimensions of valves with these facings.

Fig. 2 Welding Ends

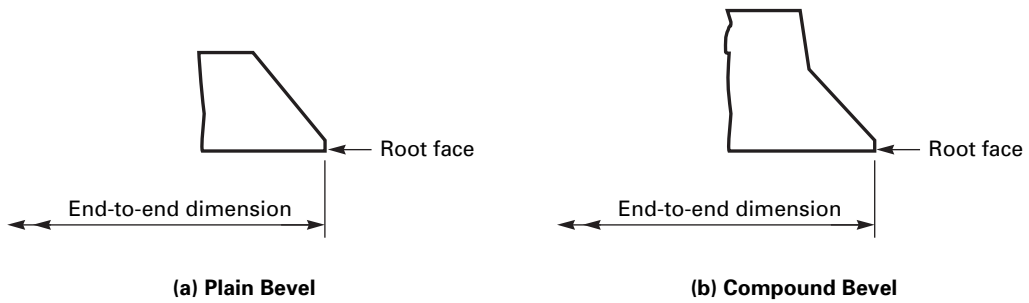

GENERAL NOTE: Typical bevels are shown for illustration only.

Table 1 Class 125 Cast Iron Flanged and Class 150 Steel Flanged and Buttwelding End Valves, Face-to-Face and End-to-End Dimensions

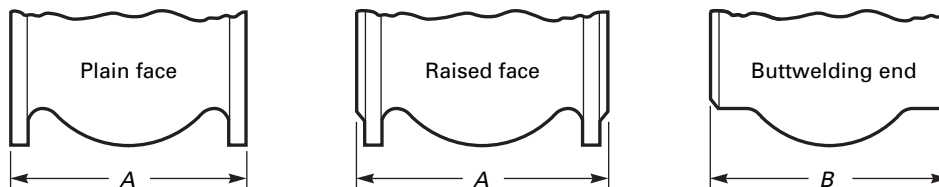

Class 125 Cast Iron

Class 150 Steel

Class 150 Steel

		1	2	3	4	5	6	7	8	9	10	11	12
		Class 125 Cast Iron					Class 150 Steel						
		Flanged End (Flat Face)					Flanged End (2 mm Raised Face) and Welding End						
		Gate, Solid Wedge and Double Disc, A	Plug				Globe, Lift Check and Swing Check Type A [Note (1)] AWWA C508, A	Globe, Lift Check, and Swing Check [Note (1)], A	Angle and Lift Check, D	Gate			Plug
NPS	DN		Short Pattern, A	Long Pattern AWWA C517, A	Regular and Venturi Pattern, A	Round Port, Full Bore, A				Solid Wedge and Double Disc, A	Conduit, A	Solid Wedge, Double Disc, and Conduit, B	Short Pattern, A
1/4	8	102	...	102	...
3/8	10	102	...	102	...
1/2	15	108	...	108	...
3/4	20	117	...	117	...
1	25	...	140	...	140 (2)	140	127	...	127	140
1 1/4	32	165 (2)	152	140	...	140	...
1 1/2	40	...	165	...	165 (2)	165	165	...	165	165
2	50	178	178	...	190 (2)	190	203	203	102	178	178	216	178
2 1/2	65	190	190	...	210 (2)	210	254	216	108	190	190	241	190
3	80	203	203	...	229 (2)	229	279	241	121	203	203	282	203
4	100	229	229	...	229 (2)	305	330	292	146	229	229	305	229
5	125	254	254	...	356 (2)	381	...	330	165	254	...	381	254
6	150	267	267	...	394	457	406	356	178	267	267	403	267
8	200	292	292	...	457	559	495	495	248	292	292	419	292
10	250	330	330	...	533	660	559	622	311	330	330	457	330
12	300	356	356	...	610	762	660	698	349	356	356	502	356
14	350	381 (5)	432 (6)	...	686	...	762	787	394	381	381	572	...
16	400	406 (5)	451 (6)	610	762	...	775	914 (7)	457	406	406	610	...
18	450	432 (5)	546 (6)	762	864	...	851	1 016 (9)	...	432	432	660	...
20	500	457 (5)	597 (6)	914	914	...	1 016	1 016 (9)	...	457	457	711	...

7

Table 1 Class 125 Cast Iron Flanged and Class 150 Steel Flanged and Butt welding End Valves, Face-to-Face and End-to-End Dimensions

(Cont'd)

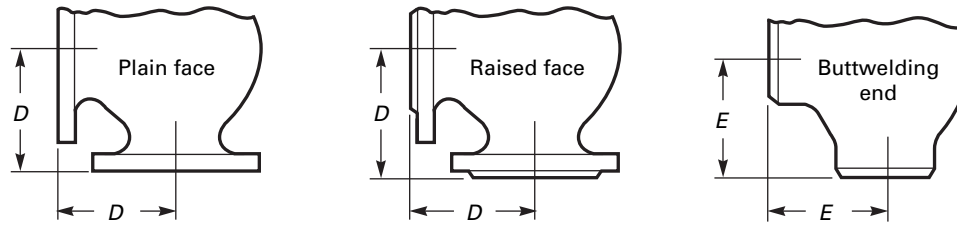

Class 125 Cast Iron

Class 150 Steel

Class 150 Steel

		13	14	15	16	17	18	19	20	21	22	23
		Class 150 Steel										
		Flanged End (2 mm Raised Face) and Welding End							Flanged End		Welding End	
		Plug				Globe, Lift Check, and Swing Check [Note (1)], A and B	Angle and Lift Check, D and E	Y-Globe and Y-Swing Check, A and B	Ball			
Nominal Valve Size		Regular Pattern, A	Short and Regular Pattern, B	Venturi Pattern, A	Round Port, Full Bore, A				Long Pattern, A	Short Pattern, A	Long Pattern, B	Short Pattern, B
NPS	DN											
1/4	8	102	51
3/8	10	102	51
1/2	15	108	57	140	108	108	...	140
3/4	20	117	64	152	117	117	...	152
1	25	176	127	70	165	127	127	...	165
1 1/4	32	140	76	184	140	140	...	178
1 1/2	40	222	165	83	203	165	165	190	190
2	50	...	267	178	267	203	102	229	178	178	216	216
2 1/2	65	...	305	...	298	216	108	279	190	190	241	241
3	80	...	330	203	343	241	121	318	203	203	282	282
4	100	305	356	229	432	292	146	368	229	229	305	305
5	125	381	381	356 (3)	178
6	150	394	457	394	546 (4)	406 (3)	203	470	394	267	457	403
8	200	457	521	457	622 (4)	495	248	597	457	292	521	419
10	250	533	559	533	660 (4)	622	311	673	533	330	559	457
12	300	610	635	610	762 (4)	698	349	775	610	356	635	502
14	350	686	...	686	...	787	394	...	686	381	762	572
16	400	762	...	762	...	914 (8)	457	...	762	406	838	610
18	450	864	...	864	...	978 (10)	864	...	914	660
20	500	914	...	914	...	978 (10)	914	...	991	711

8

Table 1 Class 125 Cast Iron Flanged and Class 150 Steel Flanged and Buttwelding End Valves, Face-to-Face and End-to-End Dimensions (Cont'd)

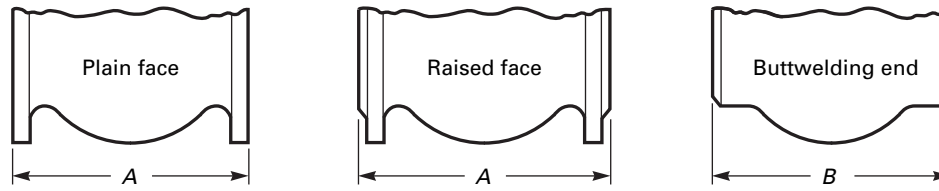

Class 125 Cast Iron

Class 150 Steel

Class 150 Steel

		1	2	3	4	5	6	7	8	9	10	11	12
		Class 125 Cast Iron					Class 150 Steel						
		Flanged End (Flat Face)					Flanged End (2 mm Raised Face) and Welding End						
Nominal Valve Size		Gate, Solid Wedge and Double Disc, A	Plug				Globe, Lift Check and Swing Check Type A [Note (1)] AWWA C508, A	Globe, Lift Check, and Swing Check [Note (1)], A	Angle and Lift Check, D	Gate			Plug
NPS	DN		Short Pattern, A	Long Pattern AWWA C517, A	Regular and Venturi Pattern, A	Round Port, Full Bore, A				Solid Wedge and Double Disc, A	Conduit, A	Solid Wedge, Double Disc, and Conduit, B	
22	550	508	762	...
24	600	508 (5)	762 (6)	1 067	1 067 (11)	...	1 168	1 219 (9)	...	508	508	813	...
26	650	559	559	864 (12)	...
28	700	610	610	914 (12)	...
30	750	...	952 (6)	1 295	1 295 (11)	1 422 (9)	...	610	660	914 (12)	...
32	800	711 (14)	711	965 (12)	...
34	850	762 (14)	762	1 016 (12)	1 016
36	900	...	1 321 (6)	1 524	1 600 (11)	1 600 (9)	...	711	813	1 016 (12)	...
40	1 000	813
42	1 050	...	1 575 (6)	1 829	1 778 (9)
48	1 200	2 134	1 930 (9)
54	1 350	2 438
60	1 500	2 667
66	1 650	2 921
72	1 800	3 175

9

Table 1 Class 125 Cast Iron Flanged and Class 150 Steel Flanged and Butt welding End Valves, Face-to-Face and End-to-End Dimensions (Cont'd)

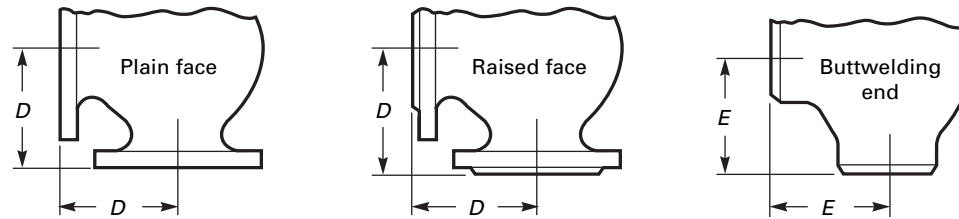

Class 125 Cast Iron

Class 150 Steel

Class 150 Steel

		13	14	15	16	17	18	19	20	21	22	23
		Class 150 Steel										
		Flanged End (2 mm Raised Face) and Welding End							Flanged End		Welding End	
		Plug				Globe, Lift Check, and Swing Check [Note (1)], A and B	Angle and Lift Check, D and E	Y-Globe and Y-Swing Check, A and B	Ball			
Nominal Valve Size		Regular Pattern, A	Short and Regular Pattern, B	Venturi Pattern, A	Round Port, Full Bore, A				Long Pattern, A	Short Pattern, A	Long Pattern, B	Short Pattern, B
NPS	DN											
22	550	1 067 (10)	1 092	...
24	600	1 067	...	1 067	...	1 295 (10)	1 067	...	1 143	813
26	650	1 295 (10)	1 143 (13)	...	1 245	...
28	700	1 448 (10)	1 245 (13)	...	1 346	...
30	750	1 524 (10)	1 295 (13)	...	1 397	...
32	800	1 372 (13)	...	1 524	...
34	850	1 473 (13)	...	1 626	...
36	900	1 956 (10)	1 524 (13)	...	1 727	...
38
40
42
44
46
48

Table 1 Class 125 Cast Iron Flanged and Class 150 Steel Flanged and Buttwelding End Valves, Face-to-Face and End-to-End Dimensions (Cont'd)

GENERAL NOTES:

- (a) Dimensions are in millimeters.
- (b) See Table 9 for adjustments to tabulated dimensions that may be required for certain flange facings.

NOTES:

- (1) These dimensions are not intended to cover the type of check valve having the seat angle at approximately 45 deg to the run of the valve, or the "Underwriter Pattern," or other patterns where large clearances are required.
- (2) Regular pattern only. The face-to-face dimension of NPS 4 (DN 100) may be 305 at the manufacturer's option.
- (3) Globe and horizontal lift check only. The face-to-face and end-to-end dimension for Class 150 steel flanged and buttwelding end swing check valves in NPS 5 (DN 125) is 330 and in NPS 6 (DN 150) is 356.
- (4) These data for Class 150 round port full bore plug valves are extracted from API 6D.
- (5) Solid wedge only.
- (6) These data for NPS ≥ 14 (DN ≥ 350) Class 125 cast iron plug valves are extracted from AWWA C517.
- (7) Globe and horizontal lift check only.
- (8) Globe and horizontal lift check only. The face-to-face and end-to-end dimension for Class 150 steel flanged and buttwelding end swing check valves in NPS 16 (DN 400) is 864.
- (9) These data for NPS ≥ 18 (DN ≥ 450) Class 125 cast iron globe and check valves are extracted from AWWA C508, Type B.
- (10) Swing check only.
- (11) Venturi pattern only.
- (12) Double disc and conduit only.
- (13) These data for Class 150 ball valves are extracted from API 6D.
- (14) These data for Class 150 gate valves are extracted from API 6D. For NPS 30 (DN 750) and NPS 36 (DN 900) through-conduit valves, use 660 mm and 813 mm, respectively.

Table 2 Class 250 Cast Iron Flanged and Class 300 Steel Flanged and Buttwelding End Valves, Face-to-Face and End-to-End Dimensions

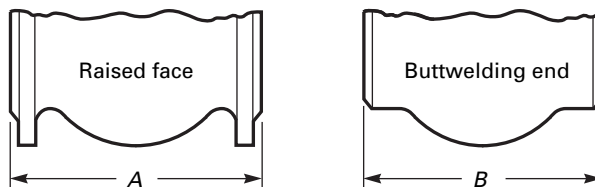

**Class 250 Cast Iron
and Class 300 Steel**

Class 300 Steel

		1	2	3	4	5	6	7	8	9
		Class 250 Cast Iron						Class 300 Steel		
		Flanged End (2 mm Raised Face)						Flanged and Welding End		
Nominal Valve Size		Gate, Solid Wedge and Double Disc, A	Plug			Globe, Lift Check, and Swing Check, A	Angle and Lift Check, D	Ball		
			Short Pattern, A	Regular Pattern, A	Venturi Pattern, A			Long Pattern, A	Short Pattern, A and B	Long Pattern, B
NPS	DN									
1/2	15	140	140	...
3/4	20	152	152	...
1	25	159	165	165	...
1 1/4	32	178	178	...
1 1/2	40	190	190	190	190
2	50	216	184	216	...	267	133	216	216	216
2 1/2	65	241	203	241	...	292	146	241	241	241
3	80	282	235	282	...	318	159	282	282	282
4	100	305	267	305	...	356	178	305	305	305
5	125	381	...	387	...	400	200
6	150	403	378	425	403	444	222	403	403	457
8	200	419	...	502	419	533	267	502	419	521
10	250	457	568	597	457	622	311	568	457	559
12	300	502	648	711	502	711	356	648	502	635
14	350	572	762	762	572	762
16	400	610	838	838	610	838
18	450	660	914	914	660	914
20	500	711	991	991	711	991
22	550	1 118	1 092	...	1 092
24	600	787	1 143	1 143	813	1 143
26	650	1 245	...	1 245
28	700	1 346	...	1 346
30	750	1 397	...	1 397
32	800	1 524	...	1 524
34	850	1 626	...	1 626
36	900	1 727	...	1 727
38
40
42
44
46
48

Table 2 Class 250 Cast Iron Flanged and Class 300 Steel Flanged and Butt welding End Valves, Face-to-Face and End-to-End Dimensions (Cont'd)

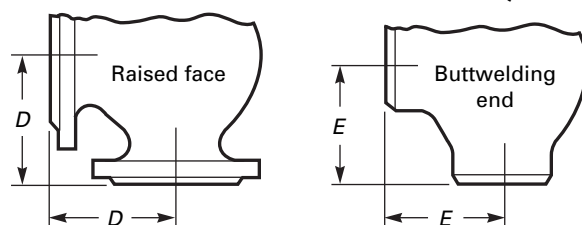

Class 250 Cast Iron and Class 300 Steel

Class 300 Steel

		10	11	12	13	14	15	16	17	
		Class 300 Steel								
		Flanged End (2 mm Raised Face) and Welding End								
Nominal Valve Size		Gate, Solid Wedge, Double Disc, and Conduit, A and B	Plug				Globe and Lift Check, A and B	Angle and Lift Check, D and E	Swing Check, A and B	
			Short and Venturi Pattern, A	Short and Venturi Pattern, B	Regular Pattern, A	Round Port, Full Bore, A and B				
NPS	DN									
1/2	15	140 (1)	152	76	...	
3/4	20	152 (1)	178	89	...	
1	25	165 (1)	159 (2)	190	203	102	216	
1 1/4	32	178 (1)	216	108	229	
1 1/2	40	190	190 (2)	241	229	114	241	
2	50	216	216	267 (2)	...	282	267	133	267	
2 1/2	65	241	241	305 (2)	...	330	292	146	292	
3	80	282	282	330 (2)	...	387	318	159	318	
4	100	305	305	356 (2)	...	457	356	178	356	
5	125	381	400	200	400	
6	150	403	403	457	403	559	444	222	444	
8	200	419	419	521	502	686	559	279	533	
10	250	457	457	559	568	826	622	311	622	
12	300	502	502	635	711	965	711	356	711	
14	350	762	762 (3)	762 (3)	762	...	838 (4)	...	838	
16	400	838	838 (3)	838 (3)	838	...	864 (4)	...	864	
18	450	914	914 (3)	914 (3)	914	...	978 (4)	...	978	
20	500	991	991 (3)	991 (3)	991	...	1 016 (4)	...	1 016	
22	550	1 092	1 092 (3)	1 092 (3)	1 092	...	1 118 (4)	...	1 118	
24	600	1 143	1 143 (3)	1 143 (3)	1 143	...	1 346 (4)	...	1 346	
26	650	1 245	1 245 (3)	1 245 (3)	1 245	...	1 346 (4)	...	1 346	
28	700	1 346	1 346 (3)	1 346 (3)	1 346	...	1 499 (4)	...	1 499	
30	750	1 397	1 397 (3)	1 397 (3)	1 397	...	1 594 (4)	...	1 594	
32	800	1 524	1 524 (3)	1 524 (3)	1 524	
34	850	1 626	1 626 (3)	1 626 (3)	1 626	
36	900	1 727	1 727 (3)	1 727 (3)	1 727	...	2 083 (4)	...	2 083	
38	
40	
42	
44	
46	
48	

**Table 2 Class 250 Cast Iron Flanged and Class 300 Steel Flanged and Buttwelding End Valves,
Face-to-Face and End-to-End Dimensions (Cont'd)**

GENERAL NOTES:

- (a) Dimensions are in millimeters.
- (b) See Table 9 for adjustments to tabulated dimensions that may be required for certain flange facings.

NOTES:

- (1) Solid wedge only.
- (2) Plug — short pattern only.
- (3) Venturi pattern only.
- (4) These data for Class 300 check valves are extracted from API 6D.

Table 3 Class 600 Steel Flanged and Buttwelding End Valves, Face-to-Face and End-to-End Dimensions

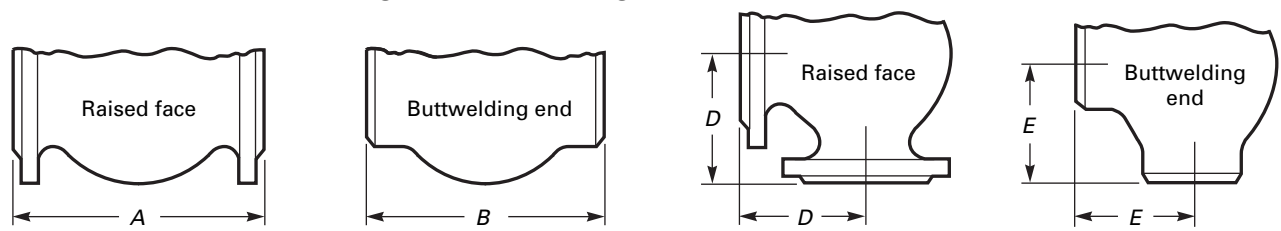

		1	2	3	4	5	6	7	8	9	10
		Class 600 Steel									
		Flanged End (7 mm Raised Face and Welding End)									
Nominal Valve Size	NPS	DN	Ball	Gate		Plug		Globe Lift Check, and Swing Check, Long Pattern, A and B	Globe Lift Check, and Swing Check, Short Pattern [Note (1)], B	Angle and Lift Check, Long Pattern, D and E	Angle and Lift Check, Short Pattern [Note (1)], E
			Long Pattern, A and B	Solid Wedge, Double Disc, and Conduit, Long Pattern, A and B	Short Pattern, [Note (1)], B	Regular and Venturi Pattern, A and B	Round Bore, Full Port, A				
1/2	15	165	165 (2)	165	...	83	...
3/4	20	190	190 (2)	190	...	95	...
1	25	216	216	133	216 (3)	254	...	216	133	108	...
1 1/4	32	229	229	146	229 (3)	229	146	114	...
1 1/2	40	241	241	152	241	318	...	241	152	121	...
2	50	292	292	178	292	330	...	292	178	146	108
2 1/2	65	330	330	216	330	381	...	330	216	165	127
3	80	356	356	254	356	444	...	356	254	178	152
4	100	432	432	305	432	508	559	432	305	216	178
5	125	...	508	381	508	381	254	216
6	150	559	559	457	559	660	711	559	457	279	254
8	200	660	660	584	660	794	845	660	584	330	...
10	250	787	787	711	787	940	1 016	787	711	394	...
12	300	838	838	813	838	1 067	1 067	838	813	419	...
14	350	889	889	889	889	889 (4)
16	400	991	991	991	991	991 (4)
18	450	1 092	1 092	1 092	1 092 (5)	1 092 (4)
20	500	1 194	1 194	1 194	1 194 (5)	1 194 (4)
22	550	1 295	1 295	...	1 295 (5)	1 295 (4)
24	600	1 397	1 397	1 397	1 397 (5)	1 397 (4)
26	650	1 448	1 448	...	1 448 (5)	1 448 (4)
28	700	1 549	1 549	1 600 (4)
30	750	1 651	1 651	...	1 651 (5)	1 651 (4)
32	800	1 778	1 778 (6)	...	1 778 (5)
34	850	1 930	1 930 (6)	...	1 930 (5)
36	900	2 083	2 083 (6)	...	2 083 (5)	2 083 (4)
38
40
42
44
46
48

Table 3 Class 600 Steel Flanged and Buttwelding End Valves, Face-to-Face and End-to-End Dimensions (Cont'd)

GENERAL NOTES:

- (a) Dimensions are in millimeters.
- (b) See Table 9 for adjustments to tabulated dimensions that may be required for certain flange facings.

NOTES:

- (1) These dimensions apply to pressure seal or flangeless bonnet valves. They may be applied at the manufacturer's option to valves with flanged bonnets.
- (2) Solid wedge only.
- (3) Regular pattern only.
- (4) Swing check only.
- (5) Venturi pattern only.
- (6) Double disc and conduit only.

Table 4 Class 900 Steel Flanged and Buttwelding End Valves, Face-to-Face and End-to-End Dimensions

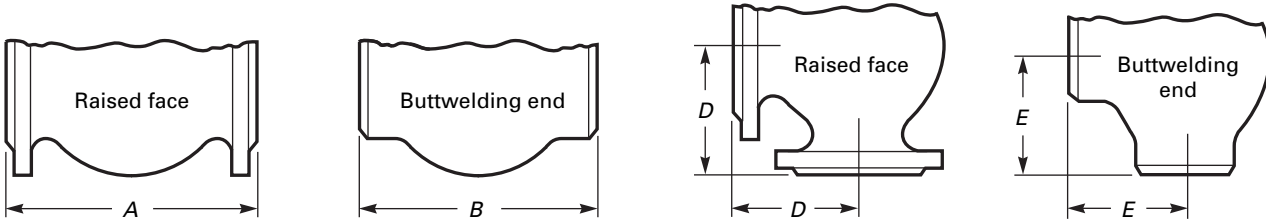

		1	2	3	4	5	6	7	8	9
		Class 900 Steel								
		Flanged End (7 mm Raised Face) and Welding End								
Nominal Valve Size		Gate		Plug		Globe Lift Check, and Swing Check, Long Pattern, A and B	Globe Lift Check, and Swing Check, Short Pattern [Note (1)], B	Angle and Lift Check, Long Pattern, D and E	Angle and Lift Check, Short Pattern [Note (1)], E	Ball
		Solid Wedge, Double Disc, and Conduit, Long Pattern, A and B	Short Pattern, [Note (1)], B	Regular and Venturi Pattern, A and B	Round Port, Full Bore, A					
NPS	DN									
3/4	20 (2)	229	...	114
1	25 (2)	254 (3)	140	254 (4)	...	254	...	127	...	254
1 1/4	32 (2)	279 (3)	165	279 (4)	...	279	...	140	...	279
1 1/2	40 (2)	305 (3)	178	305 (4)	356	305	...	152	...	305
2	50 (2)	368	216	368 (4)	381	368	...	184	...	368
2 1/2	65 (2)	419	254	419 (4)	432	419	254	210	...	419
3	80	381	305	381 (4)	470	381	305	190	152	381
4	100	457	356	457 (5)	559	457	356	229	178	457
5	125	559	432	559	432	279	216	...
6	150	610	508	610	737	610	508	305	254	610
8	200	737	660	737	813	737	660	368	330	737
10	250	838	787	838	965	838	787	419	394	838
12	300	965	914	965	1 118	965	914	483	457	965
14	350	1 029	991	1 029	991	514	495	1 029
16	400	1 130	1 092	1 130 (5)	...	1 130 (6)	1 092	660	...	1 130
18	450	1 219	1 219 (6)	...	737	...	1 219
20	500	1 321	...	1 321 (5)	...	1 321 (6)	...	826	...	1 321
22	550
24	600	1 549	1 549 (6)	...	991	...	1 549
26	650	1 651 (7)
28
30	750	1 880 (7)
32
34
36	900	2 286 (7)
38
40
42
44
46
48

Table 4 Class 900 Steel Flanged and Buttwelding End Valves, Face-to-Face and End-to-End Dimensions (Cont'd)

GENERAL NOTES:

- (a) Dimensions are in millimeters.
- (b) See Table 9 for adjustments to tabulated dimensions that may be required for certain flange facings.

NOTES:

- (1) These dimensions apply to pressure seal or flangeless bonnet valves. They may be applied at the manufacturer's option to valves with flanged bonnets.
- (2) The connecting end flanges for Class 900 valves, NPS 2½ (DN 65) and smaller, are identical to those of Class 1500 valves. The face-to-face dimensions for all Class 900 valves, NPS 2½ (DN 65) and smaller, except round port full bore plug valves (column 4), are identical with those of Class 1500 valves.
- (3) Solid wedge only.
- (4) Regular pattern only.
- (5) Venturi pattern only.
- (6) Swing check only.
- (7) These data for Class 900 full and reduced bore ball valves are extracted from API 6D.

Table 5 Class 1500 Steel Flanged and Buttwelding End Valves, Face-to-Face and End-to-End Dimensions

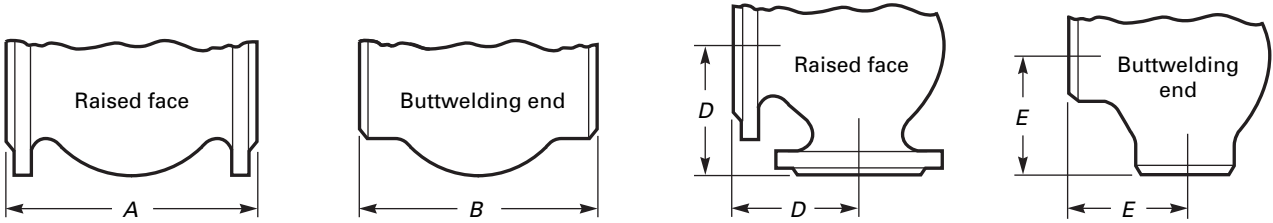

		1	2	3	4	5	6	7	8
Class 1500 Steel									
Flanged End (7 mm Raised Face) and Welding End									
Nominal Valve Size		Gate		Plug		Globe Lift Check, and Swing Check, Long Pattern, A and B	Globe Lift Check, and Swing Check, Short Pattern [Note (1)], B	Angle and Lift Check, Long Pattern, D and E	Ball
		Solid Wedge, Double Disc, and Conduit, Long Pattern, A and B	Short Pattern, [Note (1)], B	Regular and Venturi Pattern, A and B	Round Port, Full Bore, A				
NPS	DN								
1/2	15	216 (2)	...	108	...
3/4	20	229	...	114	...
1	25	254 (3)	140	254 (4)	...	254	...	127	...
1 1/4	32	279 (3)	165	279 (4)	...	279	...	140	...
1 1/2	40	305 (3)	178	305 (4)	...	305	...	152	...
2	50	368	216	368 (4)	391	368	216	184	368
2 1/2	65	419	254	419 (4)	454	419	254	210	419
3	80	470	305	470 (4)	524	470	305	235	470
4	100	546	406	546 (4)	625	546	406	273	546
5	125	673	483	673	483	337	...
6	150	705	559	705	787	705	559	353	705
8	200	832	711	832	889	832	711	416	832
10	250	991	864	991	1 067	991	864	495	991
12	300	1 130	991	1 130	1 219	1 130	991	565	1 130
14	350	1 257	1 067	1 257	1 067	629	1 257
16	400	1 384	1 194	1 384 (5)	...	1 384 (6)	1 194	...	1 384
18	450	1 537	1 346	1 537 (6)	1 537 (7)
20	500	1 664	1 473	1 664 (6)	1 664 (7)
22	550
24	600	1 943	1 943 (6)
26	650	1 943 (7)

Table 5 Class 1500 Steel Flanged and Buttwelding End Valves, Face-to-Face and End-to-End Dimensions (Cont'd)

GENERAL NOTES:

- (a) Dimensions are in millimeters.
- (b) See Table 9 for adjustments to tabulated dimensions that may be required for certain flange facings.

NOTES:

- (1) These dimensions apply to pressure seal or flangeless bonnet valves. They may be applied at the manufacturer's option to valves with flanged bonnets.
- (2) Globe and lift check only.
- (3) Solid wedge only.
- (4) Regular pattern only.
- (5) Venturi pattern only.
- (6) Swing check only.
- (7) These data for Class 1500 full and reduced bore valves are extracted from API 6D.

Table 6 Class 2500 Steel Flanged and Buttwelding End Valves, Face-to-Face and End-to-End Dimensions

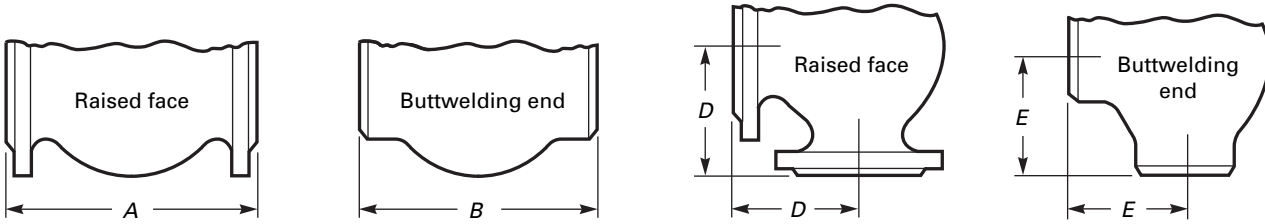

		1	2	3	4	5	6	7
		Class 2500 Steel						
		Flanged End (7 mm Raised Face) and Welding End						
		Gate		Plug Regular Pattern, A and B	Globe Lift Check, and Swing Check, Long Pattern, A and B	Globe Lift Check, and Swing Check, Short Pattern [Note (1)], B	Angle and Lift Check, Long Pattern, D and E	Ball
Nominal Valve Size		Solid Wedge, Double Disc, and Conduit, Long Pattern, A and B	Short Pattern, [Note (1)], B					Long Pattern, A and B
NPS	DN							
1/2	15	264 (2)	264	...	132	...
3/4	20	273 (2)	273	...	137	...
1	25	308 (2)	186	308	308	...	154	...
1 1/4	32	349 (2)	232	...	349	...	175	...
1 1/2	40	384 (2)	232	384	384	...	192	...
2	50	451	279	451	451	279	226	451
2 1/2	65	508	330	508	508	330	254	508
3	80	578	368	578	578	368	289	578
4	100	673	457	673	673	457	337	673
5	125	794	533	794	794	533	397	...
6	150	914	610	914	914	610	457	914
8	200	1 022	762	1 022	1 022	762	511	1 022
10	250	1 270	914	1 270	1 270	914	635	1 270
12	300	1 422	1 041	1 422	1 422	1 041	711	1 422
14	350	...	1 118
16	400	...	1 245
18	450	...	1 397

GENERAL NOTES:

- (a) Dimensions are in millimeters.
- (b) See Table 9 for adjustments to tabulated dimensions that may be required for certain flanged facings.

NOTES:

- (1) These dimensions apply to pressure seal or flangeless bonnet valves. They may be applied at the manufacturer's option to valves with flanged bonnets.
- (2) Solid wedge only.

Table 7 Classes 125 and 250 Cast Iron and Classes 150 to 2500 Steel Wafer Type Valves, Face-to-Face Dimensions

		1	2	3	4	5	6	7	8	9	10	11	12	13	14	15	16	17	18	
Nominal Valve Size		Steel					Cast Iron [Note (3)]		Swing Check, Single and Dual Plate, Installation Between Standard ANSI Flanges [Note (4)]											
		Bonnetless Knife Gate, CWP Rating (150°F Max.) [Note (1)]	Bonnetless Knife Gate Short Pattern, Class 150 [Note (2)]	Bonnetless Knife Gate Long Pattern, Class 150 [Note (2)]	Bonnetless Knife Gate Short Pattern, Class 300 [Note (2)]	Bonnetless Knife Gate Long Pattern, Class 300 [Note (2)]	Swing Check, Single and Dual Plate, Installation Between Standard ANSI Flanges		Class Long Pattern [Note (5)]						Class Short Pattern [Note (6)]					
									Class		150	300	600	900	1500	1250	150	300	600	900
		NPS	DN						125	250										
2	50	48	50.8	69.8	69.8	69.8	54	54	60	60	60	70	70	70	19	19	19	19	19	
2½	65	60	60	67	67	67	83	83	83	19	19	19	19	19	
3	80	51	50.8	101.6	69.8	101.6	67	67	73	73	73	83	83	86	19	19	19	19	22	
4	100	51	50.8	104.6	69.8	104.6	67	67	73	73	79	102	102	105	19	19	22	22	32	
5	125	57	83	83	
6	150	57	57.2	63.5	80.0	104.6	95	95	98	98	136	159	159	159	19	22	29	35	44	
8	200	70	69.8	73.2	88.9	117.6	127	127	127	127	165	206	206	206	29	29	38	44	57	
10	250	70	69.8	79.2	118.9	136.6	140	140	146	146	213	241	248	254	29	38	57	57	73	
12	300	76	76.2	82.6	127.0	143.0	181	181	181	181	229	292	305	305	38	51	60	
14	350	76	76.2	91.9	139.7	158.8	184	222	184	222	273	356	356	...	44	51	67	
16	400	89	88.9	95.2	139.7	168.4	191	232	191	232	305	384	384	...	51	51	73	
18	450	89	88.9	104.6	158.8	177.8	203	264	203	264	362	451	468	...	60	76	83	
20	500	114	114.3	114.3	189.0	189.0	213	292	219	292	368	451	533	...	64	83	92	
24	600	114	114.3	127.0	215.9	215.9	222	318	222	318	438	495	559	
26	650	...	171.4	180.1	215.9	215.9	
28	700	...	180.8	180.8	254.0	254.0	
30	750	117.0	187.4	209.6	266.7	266.7	305	368	305	368	505	
32	800	...	206.2	218.9	292.1	292.1	
36	900	117.0	225.6	249.9	304.8	304.8	368	483	368	483	635	
42	1050	...	247.6	304.8	304.8	374.6	432	568	432	568	701	
48	1200	...	292.1	419.1	304.8	424.4	524	629	524	629	

GENERAL NOTES:

- (a) Dimensions are in millimeters.
- (b) The tolerances of para. 5.1 apply to face-to-face dimensions for sizes NPS 24 (DN 600) and smaller. For sizes NPS 30 (DN 750) and larger, the tolerance shall be ±6.0 mm.

NOTES:

- (1) These data are for CWP rated knife gate valves are extracted from MSS SP-81.
- (2) These data for Class rated knife gate valves are extracted from MSS SP-135.
- (3) These data for cast iron swing check valves are extracted from API 594.
- (4) Valves of sizes NPS 30 (DN 750) and larger in Class 150, 300, and 600 shall have body outside diameters and gasket surface dimensions compatible with flange standards specified in the purchase order, e.g., ASME B16.47 Series B or ASME B16.47 Series A (MSS SP-44).
- (5) These data for long pattern steel swing check valves in sizes NPS 24 (DN 600) and smaller are extracted from API 6D and API 594. Data for larger sizes are extracted from API 594.
- (6) These data for short pattern steel swing check valves are extracted from API 6D.

Table 8 Classes 25 and 125 Cast Iron and Classes 150 to 600 Steel Butterfly Valves, Face-to-Face Dimensions

		1	2	3	4	5	6	7	8	9
		Class 150 Cast Iron and Steel [Notes (1), (2), and (3)]					Steel Grooved End [Notes (1), (3)]	Steel Offset Seat Lug and Wafer Style [Notes (4), (5)]		
Nominal Valve Size		Flanged End		Lug and Wafer Style [Note (6)]			Class 150	Class 150	Class 300	Class 600
NPS	DN	Narrow	Wide	Narrow	Wide	Extra Wide				
1½	40	33	37	38	86
2	50	43	44	46	81
2½	65	46	49	51	97
3	80	127	127	46	49	51	97	48	48	54
4	100	127	178	52	56	57	116	54	54	64
5	125	127	190	56	64	65	148
6	150	127	203	56	70	71	148	57	59	78
8	200	152	216	60	71	75	133	64	73	102
10	250	203	381	68	76	79	159	71	83	117
12	300	203	381	78	83	86	165	81	92	140
14	350	203	406	78	92	95	178	92	117	155
16	400	203	406	79	102	105	178	102	133	178
18	450	203	406	102	114	117	203	114	149	200
20	500	203	457	111	127	130	216	127	159	216
24	600	203	457	...	154	157	254	154	181	232
30	750	305	559	...	165
36	900	305	559	...	200
42	1 050	305	610	...	251
48	1 200	381	660	...	276
54	1 350	381	711
60	1 500	381	762
66	1 650	457	864
72	1 800	457	914

GENERAL NOTE: Dimensions are in millimeters.

NOTES:

- (1) These butterfly valves are of the design generally having concentric location of disc and seat, covered by MSS SP-67, from which these data are extracted.
- (2) These valves are dimensionally compatible with flanges conforming to ASME B16.1 Class 25 or Class 125, ASME B16.5 Class 150, ASME B16.24 Class 150, ASME B16.42 Class 150, or AWWA C207.
- (3) For these butterfly valves, a tolerance of ± 2.0 mm shall be allowed on face-to-face dimensions of valves of NPS 6 (DN 150) and smaller, and a tolerance of ± 3.0 mm on NPS 8 (DN 200) and larger, except that for single flange and flangeless valves of NPS 30 (DN 750) and larger, a tolerance of ± 6.0 mm shall be allowed.
- (4) For these valves, a tolerance of ± 3.0 mm shall be allowed on the face-to-face dimensions for all sizes and pressure classes.
- (5) The data for offset seat valves, columns 7 through 9, are extracted from MSS SP-68 and API 609.
- (6) The installed face-to-face dimension is the dimension of the valve face-to-face after installation in the pipeline. It does not include the thickness of gaskets where separate gaskets are used. It does include the compressed (installed) thickness of gaskets or seals that are an integral part of the valve.

Table 9 Determination of Face-to-Face and End-to-End Dimensions of Flanged Valves Having Various Flange Facings

Material	Class	Flat Face	Face-to-Face [Notes (1) and (2)]				Ring Type Joint	Large or Small	
			2 mm Raised Face	7 mm Raised Face	Large or Small			Female Face	Groove Face
					Male Face	Tongue Face			
Cast Iron	125	(3)
	250	...	(3)
Steel	125	(4)	(3)	...	+13	+13	(5)	+10	+10
	300	(4)	(3)	...	+13	+13	(5)	+10	+10
	600 to 2500	(3)	(6)	(6)	(5)	-3	-3

GENERAL NOTE: Dimensions are in millimeters.

NOTES:

- (1) To determine the face-to-face or end-to-end dimensions of valves having both flanges as tabulated in this table, adjust the face-to-face (not the butt-weld end-to-end) dimensions shown for the valve type (gate, globe, etc.), material, class, and size in Tables 1 through 6 by the amount shown.
- (2) For center-to-face or center-to-end dimensions of angle type valves, use one-half the numerical adjustment shown herein.
- (3) These face-to-face dimensions are listed in Tables 1 through 6. (See table of desired Class Number.)
- (4) For Class 150 and for Class 300 steel valves having flat faces, either the full thickness of the flange or the thickness with the 2 mm raised face removed may be supplied unless otherwise specified. For full thickness of flange, the face-to-face dimensions listed for 2 mm raised face apply. Users are reminded that removing the 2 mm raised faces will make the face-to-face dimensions nonstandard.
- (5) The *X* dimensions given in Table 10 added to the appropriate raised face flange face-to-face dimensions of Tables 1 through 6 establish the end-to-end dimensions of steel valves having flanges with ring joint facings.
- (6) These face-to-face dimensions are those listed for 7 mm raised face in Tables 3 through 6.

Table 10 Classes 150 to 2500 Steel Valves Having End Flanges With Ring Joint Facings, End-to-End Dimensions

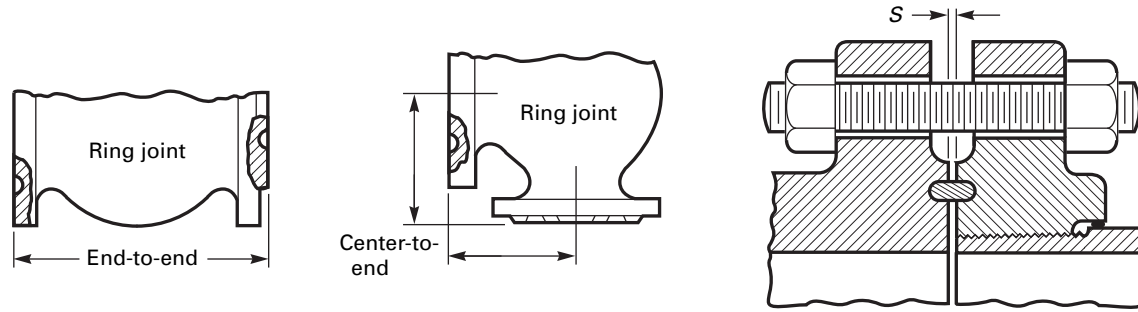

Nominal Valve Size		1	2	3	4	5	6	7	8	9	10	11	12
		Class 150		Class 300		Class 600		Class 900		Class 1500		Class 2500	
NPS	DN	X	S	X	S	X	S	X	S	X	S	X	S
1/2	15	11	3	-2 (1)	3	0	4	0	4	0	4
3/4	20	13	4	0	4	0	4	0	4	0	4
1	25	13	4	13	4	0	4	0	4	0	4	0	4
1 1/4	32	13	4	13	4	0	4	0	4	0	4	3	3
1 1/2	40	13	4	13	4	0	4	0	4	0	4	3	3
2	50	13	4	16	6	3	5	3	3	3	3	3	3
2 1/2	65	13	4	16	6	3	5	3	3	3	3	6	3
3	80	13	4	16	6	3	5	3	4	3	3	6	3
4	100	13	4	16	6	3	5	3	4	3	3	10	4
5	125	13	4	16	6	3	5	3	4	3	3	13	4
6	150	13	4	16	6	3	5	3	4	6	3	13	4
8	200	13	4	16	6	3	5	3	4	10	4	16	5
10	250	13	4	16	6	3	5	3	4	10	4	22	6
12	300	13	4	16	6	3	5	3	4	16	5	22	8
14	350	13	3	16	6	3	5	10	4	19	6
16	400	13	3	16	6	3	5	10	4	22	8
18	450	13	3	16	6	3	5	13	5	22	8
20	500	13	3	19	6	6	5	13	5	22	10
22	550	13 (2)	(3)	22 (2)	6	10 (2)	6
24	600	13	3	22	6	10	6	19	6	28	11

Table 10 Classes 150 to 2500 Steel Valves Having End Flanges With Ring Joint Facings, End-to-End Dimensions (Cont'd)

Nominal Valve Size		1	2	3	4	5	6	7	8	9	10	11	12
		Class 150		Class 300		Class 600		Class 900		Class 1500		Class 2500	
NPS	DN	X	S	X	S	X	S	X	S	X	S	X	S
26	650	25 (2)	6	13 (2)	6	21	(3)
28	700	25 (2)	6	13 (2)	6	21	(3)
30	750	25 (2)	6	13 (2)	6	21	(3)
32	800	28 (2)	(3)	16 (2)	(3)	21	(3)
34	850	28 (2)	(3)	16 (2)	(3)	27	(3)
36	900	28 (2)	(3)	16 (2)	(3)	27	(3)

GENERAL NOTES:

- Dimensions are in millimeters.
- Flanges conform to those of ASME B16.5 for the corresponding size and pressure class, except in NPS 22 (DN 550), NPS 26 (DN 650), and larger sizes. See Note (2).
- To determine the end-to-end dimensions of valves having flanges with ring joint facings, the X dimensions must be added to the nominal raised face flange face-to-face dimensions of Tables 1 through 6. For angle and angle lift check valves, one-half of the X dimensions as listed in this table must be added to the nominal dimensions for center-to-end dimensions. For approximate distance between ends of flanges having octagonal or oval ring gaskets, when rings are compressed, use S dimensions as listed in this table.

NOTES:

- This dimension has a minus value because the height of the applicable ring joint face is 1 mm less than the height of the raised face.
- Flanges for NPS 22 (DN 550), NPS 26 (DN 650), and larger sizes conform to those of MSS SP-44 and ASME B16.47, Series A for the corresponding size and pressure class.
- S dimension is not determined.

**MANDATORY APPENDIX I
FACE-TO-FACE AND END-TO-END DIMENSIONS:
U.S. CUSTOMARY UNITS**

Table I-1 Class 125 Cast Iron Flanged and Class 150 Steel Flanged and Buttwelding End Valves, Face-to-Face and End-to-End Dimensions

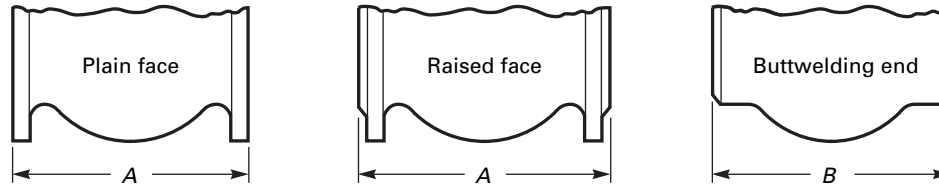

Class 125 Cast Iron

Class 150 Steel

Class 150 Steel

		1	2	3	4	5	6	7	8	9	10	11	12
		Class 125 Cast Iron							Class 150 Steel				
		Flanged End (Flat Face)							Flanged End (0.06 in., Raised Face) and Welding End				
Nominal Valve Size	Gate, Solid Wedge and Double Disc, A	Plug				Globe, Lift Check and Swing Check Type A [Note (1)] AWWA C508, A	Globe, Lift Check, and Swing Check [Note (1)], A	Angle and Lift Check, D	Gate			Plug	
		Short Pattern, A	Long Pattern AWWA C517, A	Regular and Venturi Pattern, A	Round Port, Full Bore, A				Solid Wedge and Double Disc, A	Conduit, A	Solid Wedge, Double Disc, and Conduit, B	Short Pattern, A	
NPS	DN												
1/4	8	4.00	...	4.00	...
3/8	10	4.00	...	4.00	...
1/2	15	4.25	...	4.25	...
3/4	20	4.62	...	4.62	...
1	25	...	5.50	...	5.50 (2)	5.50	5.00	...	5.00	5.50
1 1/4	32	6.50 (2)	6.00	5.50	...	5.50	...
1 1/2	40	...	6.50	...	6.50 (2)	6.50	6.50	...	6.50	6.50
2	50	7.00	7.00	...	7.50 (2)	7.50	8.00	8.00	4.00	7.00	7.00	8.50	7.00
2 1/2	65	7.50	7.50	...	8.25 (2)	8.25	10.00	8.50	4.25	7.50	7.50	9.50	7.50
3	80	8.00	8.00	...	9.00 (2)	9.00	11.00	9.50	4.75	8.00	8.00	11.12	8.00
4	100	9.00	9.00	...	9.00 (2)	12.00	13.00	11.50	5.75	9.00	9.00	12.00	9.00
5	125	10.00	10.00	...	14.00 (2)	15.00	...	13.00	6.50	10.00	...	15.00	10.00
6	150	10.50	10.50	...	15.50	18.00	16.00	14.00	7.00	10.50	10.50	15.88	10.50
8	200	11.50	11.50	...	18.00	22.00	19.50	19.50	9.75	11.50	11.50	16.50	11.50
10	250	13.00	13.00	...	21.00	26.00	22.00	24.50	12.25	13.00	13.00	18.00	13.00
12	300	14.00	14.00	...	24.00	30.00	26.00	27.50	13.75	14.00	14.00	19.75	14.00
14	350	15.00 (5)	17.00 (6)	...	27.00	...	30.00	31.00	15.50	15.00	15.00	22.50	...
16	400	16.00 (5)	17.75 (6)	24.00	30.00	...	30.50	36.00 (7)	18.00	16.00	16.00	24.00	...
18	450	17.00 (5)	21.50 (6)	30.00	34.00	...	33.50	40.00 (9)	...	17.00	17.00	26.00	...
20	500	18.00 (5)	23.50 (6)	36.00	36.00	...	40.00	40.00 (9)	...	18.00	18.00	28.00	...

Table I-1 Class 125 Cast Iron Flanged and Class 150 Steel Flanged and Butt welding End Valves, Face-to-Face and End-to-End Dimensions (Cont'd)

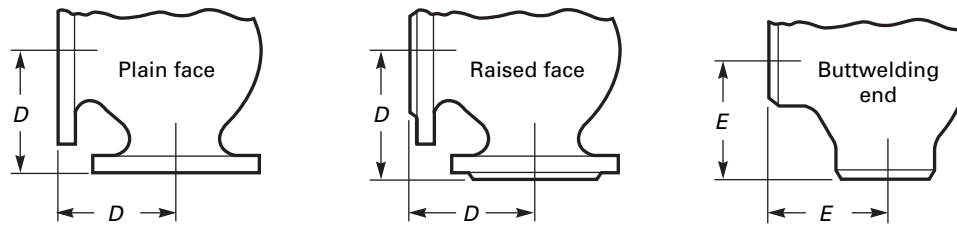

Class 125 Cast Iron

Class 150 Steel

Class 150 Steel

		13	14	15	16	17	18	19	20	21	22	23
		Class 150 Steel										
		Flanged End (0.06 in. Raised Face) and Welding End							Flanged End		Welding End	
Nominal Valve Size		Plug				Globe, Lift Check, and Swing Check [Note (1)], A and B	Angle and Lift Check, D and E	Y-Globe and Y-Swing Check, A and B	Ball			
		Regular Pattern, A	Short and Regular Pattern, B	Venturi Pattern, A	Round Port, Full Bore, A				Long Pattern, A	Short Pattern, A	Long Pattern, B	Short Pattern, B
NPS	DN	A	B	A	A	A and B	D and E	A and B	A	A	B	B
1/4	8	4.00	2.00
3/8	10	4.00	2.00
1/2	15	4.25	2.25	5.50	4.25	4.25	...	5.50
3/4	20	4.62	2.50	6.00	4.62	4.62	...	6.00
1	25	7.00	5.00	2.75	6.50	5.00	5.00	...	6.50
1 1/4	32	5.50	3.00	7.25	5.50	5.50	...	7.00
1 1/2	40	8.75	6.50	3.25	8.00	6.50	6.50	7.50	7.50
2	50	...	10.50	7.00	10.50	8.00	4.00	9.00	7.00	7.00	8.50	8.50
2 1/2	65	...	12.00	...	11.75	8.50	4.25	11.00	7.50	7.50	9.50	9.50
3	80	...	13.00	8.00	13.50	9.50	4.75	12.50	8.00	8.00	11.12	11.12
4	100	12.00	14.00	9.00	17.00	11.50	5.75	14.50	9.00	9.00	12.00	12.00
5	125	15.00	15.00	14.00 (3)	7.00
6	150	15.50	18.00	15.50	21.50 (4)	16.00 (3)	8.00	18.50	15.50	10.50	18.00	15.88
8	200	18.00	20.50	18.00	24.50 (4)	19.50	9.75	23.50	18.00	11.50	20.50	16.50
10	250	21.00	22.00	21.00	26.00 (4)	24.50	12.25	26.50	21.00	13.00	22.00	18.00
12	300	24.00	25.00	24.00	30.00 (4)	27.50	13.75	30.50	24.00	14.00	25.00	19.75
14	350	27.00	...	27.00	...	31.00	15.50	...	27.00	15.00	30.00	22.50
16	400	30.00	...	30.00	...	36.00 (8)	18.00	...	30.00	16.00	33.00	24.00
18	450	34.00	...	34.00	...	38.50 (10)	34.00	...	36.00	26.00
20	500	36.00	...	36.00	...	38.50 (10)	36.00	...	39.00	28.00

Table I-1 Class 125 Cast Iron Flanged and Class 150 Steel Flanged and Butt welding End Valves, Face-to-Face and End-to-End Dimensions (Cont'd)

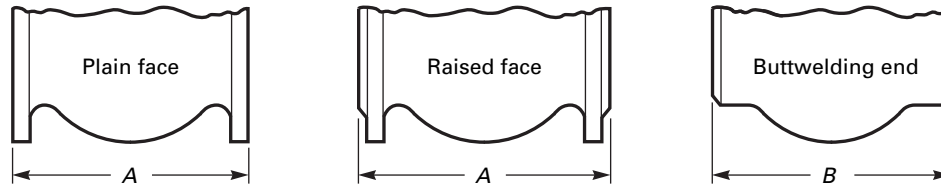

Class 125 Cast Iron

Class 150 Steel

Class 150 Steel

		1	2	3	4	5	6	7	8	9	10	11	12
		Class 125 Cast Iron								Class 150 Steel			
		Flanged End (Flat Face)								Flanged End (0.06 in., Raised Face) and Welding End			
Nominal Valve Size		Gate, Solid Wedge and Double Disc, A	Plug				Globe, Lift Check and Swing Check Type A [Note (1)] AWWA C508, A	Globe, Lift Check, and Swing Check [Note (1)], A	Angle and Lift Check, D	Gate			Plug
NPS	DN		Short Pattern, A	Long Pattern AWWA C517, A	Regular and Venturi Pattern, A	Round Port, Full Bore, A				Solid Wedge and Double Disc, A	Conduit, A	Solid Wedge, Double Disc, and Conduit, B	Short Pattern, A
22	550	20.00	30.00	...
24	600	20.00 (5)	30.00 (6)	42.00	42.00 (11)	...	46.00	48.00 (9)	...	20.00	20.00	32.00	...
26	650	22.00	22.00	34.00 (12)	...
28	700	24.00	24.00	36.00 (12)	...
30	750	...	37.50 (6)	51.00	51.00 (11)	56.00 (9)	...	24.00	26.00	36.00 (12)	...
32	800	28.00 (14)	28.00	38.00 (12)	...
34	850	30.00 (14)	30.00	40.00 (12)	40.00
36	900	...	52.00 (6)	60.00	63.00 (11)	63.00 (9)	...	28.00	32.00	40.00 (12)	...
40	1 000	32.00
42	1 050	...	62.00 (6)	72.00	70.00 (9)
48	1 200	84.00	76.00 (9)
54	1 350	96.00
60	1 500	105.00
66	1 650	115.00
72	1 800	125.00

30

Table I-1 Class 125 Cast Iron Flanged and Class 150 Steel Flanged and Butt welding End Valves, Face-to-Face and End-to-End Dimensions (Cont'd)

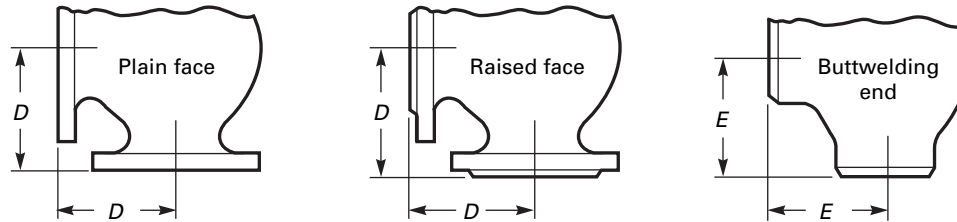

Class 125 Cast Iron

Class 150 Steel

Class 150 Steel

		13	14	15	16	17	18	19	20	21	22	23
		Class 150 Steel										
		Flanged End (0.06 in. Raised Face) and Welding End							Flanged End		Welding End	
		Plug				Globe, Lift Check, and Swing Check [Note (1)], A and B	Angle and Lift Check, D and E	Y-Globe and Y-Swing Check, A and B	Ball			
Nominal Valve Size		Regular Pattern, A	Short and Regular Pattern, B	Venturi Pattern, A	Round Port, Full Bore, A				Long Pattern, A	Short Pattern, A	Long Pattern, B	Short Pattern, B
NPS	DN											
22	550	42.00 (10)	43.00	...
24	600	42.00	...	42.00	...	51.00 (10)	42.00	...	45.00	32.00
26	650	51.00 (10)	45.00 (13)	...	49.00	...
28	700	57.00 (10)	49.00 (13)	...	53.00	...
30	750	60.00 (10)	51.00 (13)	...	55.00	...
32	800	54.00 (13)	...	60.00	...
34	850	58.00 (13)	...	64.00	...
36	900	77.00 (10)	60.00 (13)	...	68.00	...
38
40
42
44
46
48

Table I-1 Class 125 Cast Iron Flanged and Class 150 Steel Flanged and Buttwelding End Valves, Face-to-Face and End-to-End Dimensions (Cont'd)

GENERAL NOTES:

- (a) Dimensions are in inches.
- (b) See Table I-9 for adjustments to tabulated dimensions that may be required for certain flange facings.

NOTES:

- (1) These dimensions are not intended to cover the type of check valve having the seat angle at approximately 45 deg to the run of the valve, or the "Underwriter Pattern," or other patterns where large clearances are required.
- (2) Regular pattern only. The face-to-face dimension of NPS 4 may be 12.00 at the manufacturer's option.
- (3) Globe and horizontal lift check only. The face-to-face and end-to-end dimension for Class 150 steel flanged and buttwelding end swing check valves in NPS 5 is 13.00 and in NPS 6 is 14.00.
- (4) These data for Class 150 round port full bore plug valves are extracted from API 6D.
- (5) Solid wedge only.
- (6) These data for NPS ≥ 14 (DN ≥ 350) Class 125 cast iron plug valves are extracted from AWWA C517.
- (7) Globe and horizontal lift check only.
- (8) Globe and horizontal lift check only. The face-to-face and end-to-end dimension for Class 150 steel flanged and buttwelding end swing check valves in NPS 16 is 34.00
- (9) These data for NPS ≥ 18 (DN ≥ 450) Class 125 cast iron globe and check valves are extracted from AWWA C508, Type B.
- (10) Swing check only.
- (11) Venturi pattern only.
- (12) Double disc and conduit only.
- (13) These data for Class 150 ball valves are extracted from API 6D.
- (14) These data for Class 150 gate valves are extracted from API 6D. For NPS 30 (DN 750) and NPS 36 (DN 900) through-conduit valves, use 26.00 in. and 32.00 in., respectively.

Table I-2 Class 250 Cast Iron Flanged and Class 300 Steel Flanged and Buttwelding End Valves, Face-to-Face and End-to-End Dimensions

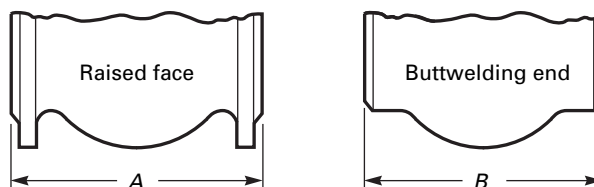

Class 250 Cast Iron and Class 300 Steel

Class 300 Steel

		1	2	3	4	5	6	7	8	9
		Class 250 Cast Iron						Class 300 Steel		
		Flanged End (0.06 in. Raised Face)						Flanged and Welding End		
Nominal Valve Size		Gate, Solid Wedge and Double Disc, A	Plug			Globe, Lift Check, and Swing Check, A	Angle and Lift Check, D	Ball		
			Short Pattern, A	Regular Pattern, A	Venturi Pattern, A			Long Pattern, A	Short Pattern, A and B	Long Pattern, B
NPS	DN	A	A	A	A	A	D	A	A and B	B
1/2	15	5.50	5.50	...
3/4	20	6.00	6.00	...
1	25	6.25	6.50	6.50	...
1 1/4	32	7.00	7.00	...
1 1/2	40	7.50	7.50	7.50	7.50
2	50	8.50	7.25	8.50	...	10.50	5.25	8.50	8.50	8.50
2 1/2	65	9.50	8.00	9.50	...	11.50	5.75	9.50	9.50	9.50
3	80	11.12	9.25	11.12	...	12.50	6.25	11.12	11.12	11.12
4	100	12.00	10.50	12.00	...	14.00	7.00	12.00	12.00	12.00
5	125	15.00	...	15.25	...	15.75	7.88
6	150	15.88	14.88	16.75	15.88	17.50	8.75	15.88	15.88	18.00
8	200	16.50	...	19.75	16.50	21.00	10.50	19.75	16.50	20.50
10	250	18.00	22.38	23.50	18.00	24.50	12.25	22.38	18.00	22.00
12	300	19.75	25.50	28.00	19.75	28.00	14.00	25.50	19.75	25.00
14	350	22.50	30.00	30.00	22.50	30.00
16	400	24.00	33.00	33.00	24.00	33.00
18	450	26.00	36.00	36.00	26.00	36.00
20	500	28.00	39.00	39.00	28.00	39.00
22	550	44.00	43.00	...	43.00
24	600	31.00	45.00	45.00	32.00	45.00
26	650	49.00	...	49.00
28	700	53.00	...	53.00
30	750	55.00	...	55.00
32	800	60.00	...	60.00
34	850	64.00	...	64.00
36	900	68.00	...	68.00
38
40
42
44
46
48

Table I-2 Class 250 Cast Iron Flanged and Class 300 Steel Flanged and Butt welding End Valves, Face-to-Face and End-to-End Dimensions (Cont'd)

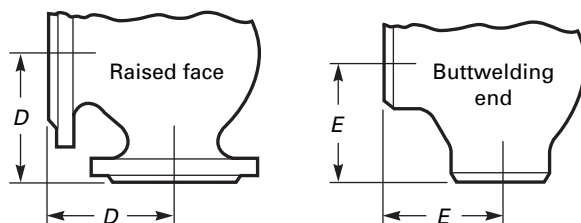

Class 250 Cast Iron and Class 300 Steel

Class 300 Steel

		10	11	12	13	14	15	16	17	
		Class 300 Steel								
		Flanged End (0.06 in. Raised Face) and Welding End								
Nominal Valve Size		Gate, Solid Wedge, Double Disc, and Conduit, A and B	Plug				Globe and Lift Check, A and B	Angle and Lift Check, D and E	Swing Check, A and B	
			Short and Venturi Pattern, A	Short and Venturi Pattern, B	Regular Pattern, A	Round Port, Full Bore, A and B				
NPS	DN									
1/2	15	5.50 (1)	6.00	3.00	...	
3/4	20	6.00 (1)	7.00	3.50	...	
1	25	6.50 (1)	6.25 (2)	7.50	8.00	4.00	8.50	
1 1/4	32	7.00 (1)	8.50	4.25	9.00	
1 1/2	40	7.50	7.50 (2)	9.50	9.00	4.50	9.50	
2	50	8.50	8.50	10.50 (2)	...	11.12	10.50	5.25	10.50	
2 1/2	65	9.50	9.50	12.00 (2)	...	13.00	11.50	5.75	11.50	
3	80	11.12	11.12	13.00 (2)	...	15.25	12.50	6.25	12.50	
4	100	12.00	12.00	14.00 (2)	...	18.00	14.00	7.00	14.00	
5	125	15.00	15.75	7.88	15.75	
6	150	15.88	15.88	18.00	15.88	22.00	17.50	8.75	17.50	
8	200	16.50	16.50	20.50	19.75	27.00	22.00	11.00	21.00	
10	250	18.00	18.00	22.00	22.38	32.50	24.50	12.25	24.50	
12	300	19.75	19.75	25.00	28.00	38.00	28.00	14.00	28.00	
14	350	30.00	30.00 (3)	30.00 (3)	30.00	...	33.00 (4)	...	33.00	
16	400	33.00	33.00 (3)	33.00 (3)	33.00	...	34.00 (4)	...	34.00	
18	450	36.00	36.00 (3)	36.00 (3)	36.00	...	38.50 (4)	...	38.50	
20	500	39.00	39.00 (3)	39.00 (3)	39.00	...	40.00 (4)	...	40.00	
22	550	43.00	43.00 (3)	43.00 (3)	43.00	...	44.00 (4)	...	44.00	
24	600	45.00	45.00 (3)	45.00 (3)	45.00	...	53.00 (4)	...	53.00	
26	650	49.00	49.00 (3)	49.00 (3)	49.00	...	53.00 (4)	...	53.00	
28	700	53.00	53.00 (3)	53.00 (3)	53.00	...	59.00 (4)	...	59.00	
30	750	55.00	55.00 (3)	55.00 (3)	55.00	...	62.75 (4)	...	62.75	
32	800	60.00	60.00 (3)	60.00 (3)	60.00	
34	850	64.00	64.00 (3)	64.00 (3)	64.00	
36	900	68.00	68.00 (3)	68.00 (3)	68.00	...	82.00 (4)	...	82.00	
38	
40	
42	
44	
46	
48	

**Table I-2 Class 250 Cast Iron Flanged and Class 300 Steel Flanged and Buttwelding End Valves,
Face-to-Face and End-to-End Dimensions (Cont'd)**

GENERAL NOTES:

- (a) Dimensions are in inches.
- (b) See Table I-9 for adjustments to tabulated dimensions that may be required for certain flange facings.

NOTES:

- (1) Solid wedge only.
- (2) Plug — short pattern only.
- (3) Venturi pattern only.
- (4) These data for Class 300 check valves are extracted from API 6D.

Table I-3 Class 600 Steel Flanged and Buttwelding End Valves, Face-to-Face and End-to-End Dimensions

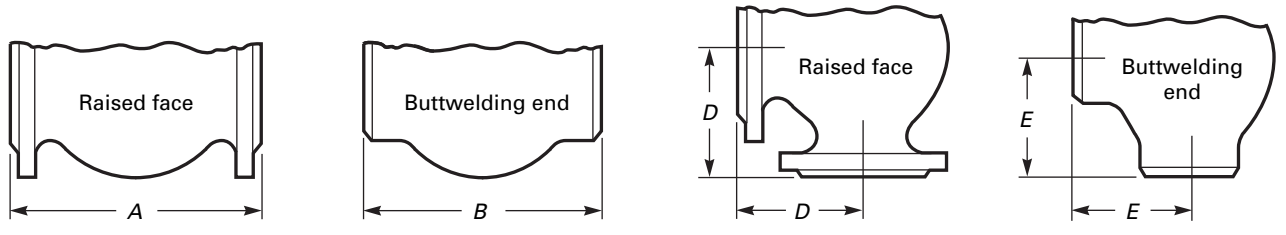

		1	2	3	4	5	6	7	8	9	10
Class 600 Steel											
Flanged End (0.25 in. Raised Face) and Welding End											
Nominal Valve Size		Ball	Gate		Plug			Globe, Lift Check, and Swing Check, Long Pattern, A and B	Globe, Lift Check, and Swing Check, Short Pattern [Note (1)], B	Angle and Lift Check, Long Pattern, D and E	Angle and Lift Check, Short Pattern [Note (1)] E
		Long Pattern, A and B	Solid Wedge, Double Disc, and Conduit, Long Pattern, A and B	Short Pattern [Note (1)], B	Regular and Venturi Pattern, A and B	Round Bore, Full Port, A	Round Bore, Full Port, B				
NPS	DN										
1/2	15	6.50	6.50 (2)	6.50	...	3.25	...
3/4	20	7.50	7.50 (2)	7.50	...	3.75	...
1	25	8.50	8.50	5.25	8.50 (3)	10.00	...	8.50	5.25	4.25	...
1 1/4	32	9.00	9.00	5.75	9.00 (3)	9.00	5.75	4.50	...
1 1/2	40	9.50	9.50	6.00	9.50	12.50	...	9.50	6.00	4.75	...
2	50	11.50	11.50	7.00	11.50	13.00	...	11.50	7.00	5.75	4.25
2 1/2	65	13.00	13.00	8.50	13.00	15.00	...	13.00	8.50	6.50	5.00
3	80	14.00	14.00	10.00	14.00	17.50	...	14.00	10.00	7.00	6.00
4	100	17.00	17.00	12.00	17.00	20.00	22.00	17.00	12.00	8.50	7.00
5	125	...	20.00	15.00	20.00	15.00	10.00	8.50
6	150	22.00	22.00	18.00	22.00	26.00	28.00	22.00	18.00	11.00	10.00
8	200	26.00	26.00	23.00	26.00	31.25	33.25	26.00	23.00	13.00	...
10	250	31.00	31.00	28.00	31.00	37.00	40.00	31.00	28.00	15.50	...
12	300	33.00	33.00	32.00	33.00	42.00	42.00	33.00 (4)	32.00	16.50	...
14	350	35.00	35.00	35.00	35.00	35.00 (4)
16	400	39.00	39.00	39.00	39.00	39.00 (4)
18	450	43.00	43.00	43.00	43.00 (5)	43.00 (4)
20	500	47.00	47.00	47.00	47.00 (5)	47.00 (4)
22	550	51.00	51.00	...	51.00 (5)	51.00 (4)
24	600	55.00	55.00	55.00	55.00 (5)	55.00 (4)
26	650	57.00	57.00	...	57.00 (5)	57.00 (4)
28	700	61.00	61.00	63.00 (4)
30	750	65.00	65.00	...	65.00 (5)	65.00 (4)
32	800	70.00	70.00 (6)	...	70.00 (5)
34	850	76.00	76.00 (6)	...	76.00 (5)
36	900	82.00	82.00 (6)	...	82.00 (5)	82.00 (4)
38
40
42
44
46
48

Table I-3 Class 600 Steel Flanged and Butt welding End Valves, Face-to-Face and End-to-End Dimensions (Cont'd)

GENERAL NOTES:

- (a) Dimensions are in inches.
- (b) See Table I-9 for adjustments to tabulated dimensions that may be required for certain flange facings.

NOTES:

- (1) These dimensions apply to pressure seal or flangeless bonnet valves. They may be applied at the manufacturer's option to valves with flanged bonnets.
- (2) Solid wedge only.
- (3) Regular pattern only.
- (4) Swing check only.
- (5) Venturi pattern only.
- (6) Double disc and conduit only.

Table I-4 Class 900 Steel Flanged and Butt welding End Valves, Face-to-Face and End-to-End Dimensions

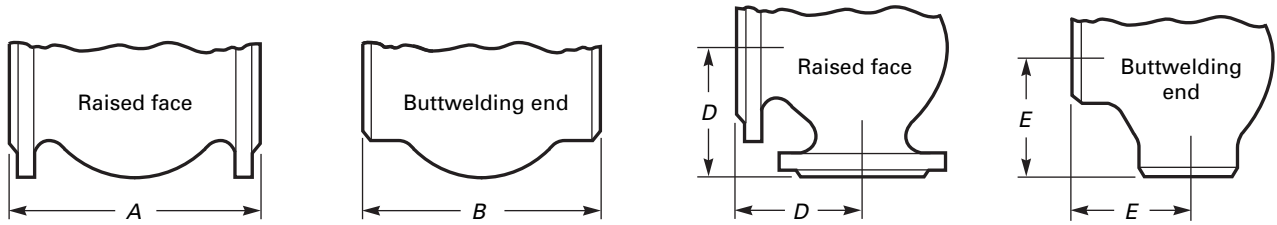

		1	2	3	4	5	6	7	8	9
		Class 900 Steel Valves								
		Flanged End (0.25 in. Raised Face) and Welding End								
Nominal Valve Size		Gate		Plug		Globe, Lift Check, and Swing Check, Long Pattern, A and B	Globe, Lift Check, and Swing Check, Short Pattern [Note (1)], B	Angle and Lift Check, Long Pattern, D and E	Angle and Lift Check, Short Pattern [Note (1)] E	Ball
		Solid Wedge, Double Disc, and Conduit, Long Pattern, A and B	Short Pattern [Note (1)], B	Regular and Venturi Pattern, A and B	Round Port, Full Bore, A					Long Pattern, A and B
NPS	DN									
3/4 (2)	20 (2)	9.00	...	4.50
1 (2)	25 (2)	10.00 (3)	5.50	10.00 (4)	...	10.00	...	5.00	...	10.00
1 1/4 (2)	32 (2)	11.00 (3)	6.50	11.00 (4)	...	11.00	...	5.50	...	11.00
1 1/2 (2)	40 (2)	12.00 (3)	7.00	12.00 (4)	14.00	12.00	...	6.00	...	12.00
2 (2)	50 (2)	14.50	8.50	14.50 (4)	15.00	14.50	...	7.25	...	14.50
2 1/2 (2)	65 (2)	16.50	10.00	16.50 (4)	17.00	16.50	10.00	8.25	...	16.50
3	80	15.00	12.00	15.00 (4)	18.50	15.00	12.00	7.50	6.00	15.00
4	100	18.00	14.00	18.00 (5)	22.00	18.00	14.00	9.00	7.00	18.00
5	125	22.00	17.00	22.00	17.00	11.00	8.50	...
6	150	24.00	20.00	24.00	29.00	24.00	20.00	12.00	10.00	24.00
8	200	29.00	26.00	29.00	32.00	29.00	26.00	14.50	13.00	29.00
10	250	33.00	31.00	33.00	38.00	33.00	31.00	16.50	15.50	33.00
12	300	38.00	36.00	38.00	44.00	38.00	36.00	19.00	18.00	38.00
14	350	40.50	39.00	40.50	39.00	20.25	19.50	40.50
16	400	44.50	43.00	44.50 (5)	...	44.50 (6)	43.00	26.00	...	44.50
18	450	48.00	48.00 (6)	...	29.00	...	48.00
20	500	52.00	...	52.00 (5)	...	52.00 (6)	...	32.50	...	52.00
22	550
24	600	61.00	61.00 (6)	...	39.00	...	61.00
26	650	65.00 (7)
28
30	750	74.00 (7)
32
34
36	900	90.00 (7)
38
40
42
44
46
48

Table I-4 Class 900 Steel Flanged and Buttwelding End Valves, Face-to-Face and End-to-End Dimensions (Cont'd)

GENERAL NOTES:

- (a) Dimensions are in inches.
- (b) See Table I-9 for adjustments to tabulated dimensions that may be required for certain flange facings.

NOTES:

- (1) These dimensions apply to pressure seal or flangeless bonnet valves. They may be applied at the manufacturer's option to valves with flanged bonnets.
- (2) The connecting end flanges for Class 900 valves, NPS 2½ and smaller, are identical to those of Class 1500 valves. The face-to-face dimensions for all Class 900 valves, NPS 2½ and smaller, except round port full bore plug valves (column 4), are identical with those of Class 1500 valves.
- (3) Solid wedge only.
- (4) Regular pattern only.
- (5) Venturi pattern only.
- (6) Swing check only.
- (7) These data for Class 900 full and reduced bore ball valves are extracted from API 6D.

Table I-5 Class 1500 Steel Flanged and Butt welding End Valves, Face-to-Face and End-to-End Dimensions

		1	2	3	4	5	6	7	8
		Class 1500 Steel							
		Flanged End (0.25 in. Raised Face) and Welding End							
		Gate		Plug		Globe, Lift Check, and Swing Check, Long Pattern, A and B	Globe, Lift Check, and Swing Check, Short Pattern [Note (1)], B	Angle and Lift Check, Long Pattern, D and E	Ball
NPS	DN	Solid Wedge, Double Disc, and Conduit, Long Pattern, A and B	Short Pattern [Note (1)], B	Regular and Venturi Pattern, A and B	Round Port, Full Bore, A				Long Pattern, A and B
1/2	15	8.50 (2)	...	4.25	...
3/4	20	9.00	...	4.50	...
1	25	10.00 (3)	5.50	10.00 (4)	...	10.00	...	5.00	...
1 1/4	32	11.00 (3)	6.50	11.00 (4)	...	11.00	...	5.50	...
1 1/2	40	12.00 (3)	7.00	12.00 (4)	...	12.00	...	6.00	...
2	50	14.50	8.50	14.50 (4)	15.38	14.50	8.50	7.25	14.50
2 1/2	65	16.50	10.00	16.50 (4)	17.88	16.50	10.00	8.25	16.50
3	80	18.50	12.00	18.50 (4)	20.62	18.50	12.00	9.25	18.50
4	100	21.50	16.00	21.50 (4)	24.62	21.50	16.00	10.75	21.50
5	125	26.50	19.00	26.50	19.00	13.25	...
6	150	27.75	22.00	27.75	31.00	27.75	22.00	13.88	27.75
8	200	32.75	28.00	32.75	35.00	32.75	28.00	16.38	32.75
10	250	39.00	34.00	39.00	42.00	39.00	34.00	19.50	39.00
12	300	44.50	39.00	44.50	48.00	44.50	39.00	22.25	44.50
14	350	49.50	42.00	49.50	42.00	24.75	49.50
16	400	54.50	47.00	54.50 (5)	...	54.50 (6)	47.00	...	54.50
18	450	60.50	53.00	60.50 (6)	60.50 (7)
20	500	65.50	58.00	65.50 (6)	65.50 (7)
22	550
24	600	76.50	76.50 (6)
26	650	76.50 (7)

GENERAL NOTES:

(a) Dimensions are in inches.

(b) See Table I-9 for adjustments to tabulated dimensions that may be required for certain flange facings.

NOTES:

(1) These dimensions apply to pressure seal or flangeless bonnet valves. They may be applied at the manufacturer's option to valves with flanged bonnets.

(2) Globe and lift check only.

(3) Solid wedge only.

(4) Regular pattern only.

(5) Venturi pattern only.

(6) Swing check only.

(7) These data for Class 1500 full and reduced bore valves are extracted from API 6D.

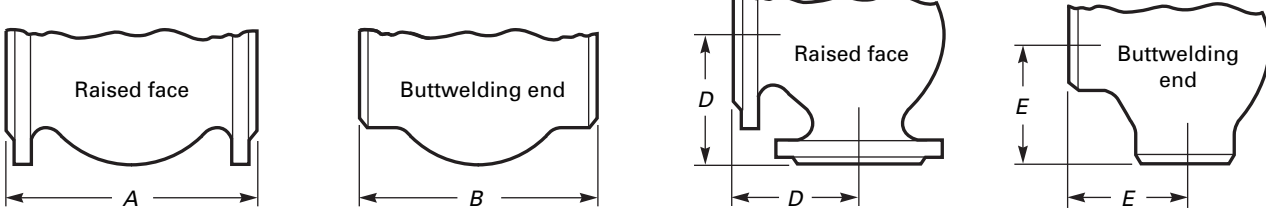
Table I-6 Class 2500 Steel Flanged and Butt welding End Valves, Face-to-Face and End-to-End Dimensions

		1	2	3	4	5	6	7
		Class 2500 Steel						
		Flanged End (0.25 in. Raised Face) and Welding End						
Nominal Valve Size	NPS	Gate		Plug, Regular Pattern, A and B	Globe, Lift Check, and Swing Check, Long Pattern, A and B	Globe, Lift Check, and Swing Check, Short Pattern [Note (1)], B	Angle and Lift Check, Long Pattern, D and E	Ball
		Solid Wedge, and Double Disc, Long Pattern, A and B	Short Pattern [Note (1)], B					Long Pattern, A and B
	DN							
1/2	15	10.38 (2)	10.38	...	5.19	...
3/4	20	10.75 (2)	10.75	...	5.38	...
1	25	12.12 (2)	7.31	12.12	12.12	...	6.06	...
1 1/4	32	13.75 (2)	9.12	...	13.75	...	6.88	...
1 1/2	40	15.12 (2)	9.12	15.12	15.12	...	7.56	...
2	50	17.75	11.00	17.75	17.75	11.00	8.88	17.75
2 1/2	65	20.00	13.00	20.00	20.00	13.00	10.00	20.00
3	80	22.75	14.50	22.75	22.75	14.50	11.38	22.75
4	100	26.50	18.00	26.50	26.50	18.00	13.25	26.50
5	125	31.25	21.00	31.25	31.25	21.00	15.62	...
6	150	36.00	24.00	36.00	36.00	24.00	18.00	36.00
8	200	40.25	30.00	40.25	40.25	30.00	20.12	40.25
10	250	50.00	36.00	50.00	50.00	36.00	25.00	50.00
12	300	56.00	41.00	56.00	56.00	41.00	28.00	56.00
14	350	...	44.00
16	400	...	49.00
18	450	...	55.00

GENERAL NOTES:

- (a) Dimensions are in inches.
 (b) See Table I-9 for adjustments to tabulated dimensions that may be required for certain flanged facings.

NOTES:

- (1) These dimensions apply to pressure seal or flangeless bonnet valves. They may be applied at the manufacturer's option to valves with flanged bonnets.
 (2) Solid wedge only.

Table I-7 Classes 125 and 250 Cast Iron and Classes 150 to 2500 Steel Wafer Type Valves, Face-to-Face Dimensions

		1	2	3	4	5	6	7	8	9	10	11	12	13	14	15	16	17	18	
Nominal Valve Size		Steel					Cast Iron [Note (3)]		Swing Check, Single and Dual Plate, Installation Between Standard ANSI Flanges[Note (4)]											
		Bonnetless Knife Gate, CWP Rating (150°F Max.) [Note (1)]	Bonnetless Knife Gate Short Pattern, Class 150 [Note (2)]	Bonnetless Knife Gate Long Pattern, Class 150 [Note (2)]	Bonnetless Knife Gate Short Pattern, Class 300 [Note (2)]	Bonnetless Knife Gate Long Pattern, Class 300 [Note (2)]	Swing Check, Single and Dual Plate, Installation Between Standard ANSI Flanges		Class Long Pattern [Note (5)]						Class Short Pattern [Note (6)]					
							Class		150	300	600	900	1500	2500	150	300	600	900	1500	
		NPS	DN						125	250	[Note (7)]									
2	50	1.88	2.00	2.75	2.75	2.75	2.12	2.12	2.38	2.38	2.38	2.75	2.75	2.75	0.75	0.75	0.75	0.75	0.75	
2½	65	2.38	2.38	2.62	2.62	2.62	3.25	3.25	3.25	0.75	0.75	0.75	0.75	0.75	
3	80	2.00	2.00	4.00	2.75	4.00	2.62	2.62	2.88	2.88	2.88	3.25	3.25	3.38	0.75	0.75	0.75	0.75	0.88	
4	100	2.00	2.00	4.12	2.75	4.12	2.62	2.62	2.88	2.88	3.12	4.00	4.00	4.12	0.75	0.75	0.88	0.88	1.25	
5	125	2.25	3.25	3.25	
6	150	2.25	2.25	2.50	3.15	4.12	3.75	3.75	3.88	3.88	5.38	6.25	6.25	6.25	0.75	0.88	1.12	1.38	1.75	
8	200	2.75	2.75	2.88	3.50	4.63	5.00	5.00	5.00	5.00	6.50	8.12	8.12	8.12	1.12	1.12	1.50	1.75	2.25	
10	250	2.75	2.75	3.12	4.68	5.38	5.50	5.50	5.75	5.75	8.38	9.50	9.75	10.00	1.12	1.50	2.25	2.25	2.88	
12	300	3.00	3.00	3.25	5.00	5.63	7.12	7.12	7.12	7.12	9.00	11.50	12.00	[Note (7)]	1.50	2.00	2.38	
14	350	3.00	3.00	3.62	5.50	6.25	7.25	8.75	7.25	8.75	10.75	14.00	14.00	...	1.75	2.00	2.62	
16	400	3.50	3.50	3.75	5.50	6.63	7.50	9.12	7.50	9.12	12.00	15.12	15.12	...	2.00	2.00	2.88	
18	450	3.50	3.50	4.12	6.25	7.00	8.00	10.38	8.00	10.38	14.25	17.75	18.44	...	2.38	3.00	3.25	
20	500	4.50	4.50	4.50	7.44	7.44	8.38	11.50	8.62	11.50	14.50	17.75	21.00	...	2.50	3.25	3.62	
24	600	4.50	4.50	5.00	8.50	8.50	8.75	12.50	8.75	12.50	17.25	19.50	22.00	
26	650	...	6.75	7.09	8.50	8.50	
28	700	...	7.12	7.12	10.00	10.00	
30	750	4.62	7.38	8.25	10.50	10.50	12.00	14.50	12.00	14.50	19.8	
32	800	...	8.12	8.62	11.50	11.50	
36	900	4.62	8.88	9.84	12.00	12.00	14.50	19.00	14.50	19.00	25.00	
42	1050	...	9.75	12.00	12.00	14.75	17.00	22.38	17.00	22.37	27.61	
48	1200	...	11.50	16.50	12.00	16.75	20.62	24.75	20.62	24.75	

GENERAL NOTES:

- (a) Dimensions are in inches.
- (b) The tolerances of para. 5.1 apply to face-to-face dimensions for sizes NPS 24 and smaller. For sizes NPS 30 and larger, the tolerance shall be ±0.25 in.

NOTES:

- (1) These data for CWP rated knife gate valves are extracted from MSS SP-81.
- (2) These data for Class rated knife gate valves are extracted from MSS SP-135.
- (3) These data for cast iron swing check valves are extracted from API 594.
- (4) Valves of sizes NPS 30 and larger in class 150, 300, and 600 shall have body outside diameters and gasket surface dimensions compatible with flange standards specified in the purchase order, e.g., ASME B16.47 Series B or ASME B16.47 Series A (MSS SP-44).
- (5) These data for long pattern steel swing check valves in sizes NPS 24 and smaller are extracted from API 6D and API 594. Data for larger sizes are extracted from API 594.
- (6) These data for short pattern steel swing check valves are extracted from API 6D.
- (7) Except for API 6D, use 9.88.

Table I-8 Classes 25 and 125 Cast Iron and Classes 150 to 600 Steel Butterfly Valves, Face-to-Face Dimensions

		1	2	3	4	5	6	7	8	9
Nominal Valve Size		Cast Iron and Class 150 Steel [Notes (1), (2), and (3)]					Steel Grooved End [Notes (1) and (3)]	Steel Offset Seat Lug and Wafer Style [Notes (4) and (5)]		
		Flanged End		Lug and Wafer Style [Note (6)]			Class 150	Class 150	Class 300	Class 600
		Narrow	Wide	Narrow	Wide	Extra Wide				
NPS	DN									
1½	40	1.31	1.44	1.50	3.38
2	50	1.69	1.75	1.81	3.19
2½	65	1.81	1.94	2.00	3.81
3	80	5.00	5.00	1.81	1.94	2.00	3.81	1.88	1.88	2.12
4	100	5.00	7.00	2.06	2.19	2.25	4.56	2.12	2.12	2.50
5	125	5.00	7.50	2.19	2.50	2.56	5.81
6	150	5.00	8.00	2.19	2.75	2.81	5.81	2.25	2.31	3.06
8	200	6.00	8.50	2.38	2.81	2.94	5.25	2.50	2.88	4.00
10	250	8.00	15.00	2.69	3.00	3.12	6.25	2.81	3.25	4.62
12	300	8.00	15.00	3.06	3.25	3.38	6.50	3.19	3.62	5.50
14	350	8.00	16.00	3.06	3.62	3.75	7.00	3.62	4.62	6.12
16	400	8.00	16.00	3.12	4.00	4.12	7.00	4.00	5.25	7.00
18	450	8.00	16.00	4.00	4.50	4.62	8.00	4.50	5.88	7.88
20	500	8.00	18.00	4.38	5.00	5.12	8.50	5.00	6.25	8.50
24	600	8.00	18.00	...	6.06	6.19	10.00	6.06	7.12	9.13
30	750	12.00	22.00	...	6.50
36	900	12.00	22.00	...	7.88
42	1050	12.00	24.00	...	9.88
48	1200	15.00	26.00	...	10.88
54	1350	15.00	28.00
60	1500	15.00	30.00
66	1650	18.00	34.00
72	1800	18.00	36.00

GENERAL NOTE: Dimensions are in inches.

NOTES:

- (1) These butterfly valves are of the design generally having concentric location of disc and seat, covered by MSS SP-67, from which these data are extracted.
- (2) These valves are dimensionally compatible with flanges conforming to ASME B16.1 Class 25 or Class 125, ASME B16.5 Class 150, ASME B16.24 Class 150, ASME B16.42 Class 150, or AWWA C207.
- (3) For these butterfly valves, a tolerance of ± 0.06 in. shall be allowed on face-to-face dimensions of valves of NPS 6 and smaller, and a tolerance of ± 0.13 in. on NPS 8 and larger, except that for single flange and flangeless valves of NPS 30 and larger, a tolerance of ± 0.25 in. shall be allowed.
- (4) For these valves, a tolerance of ± 0.13 in. shall be allowed on the face-to-face dimensions for all sizes and pressure classes.
- (5) The data for offset seat valves, columns 7 through 9, are extracted from MSS SP-68 and API 609.
- (6) The installed face-to-face dimension is the dimension of the valve face-to-face after installation in the pipeline. It does not include the thickness of gaskets where separate gaskets are used. It does include the compressed (installed) thickness of gaskets or seals that are an integral part of the valve.

Table I-9 Determination of Face-to-Face and End-to-End Dimensions of Flanged Valves Having Various Flange Facings

Material	Class	Flat Face	Face-to-Face [Notes (1) and (2)]				End-to-End [Notes (1) and (2)]		
			0.06 in. Raised Face	0.25 in. Raised Face	Large or Small		Ring Type Joint	Large or Small	
					Male Face	Tongue Face		Female Face	Groove Face
Cast iron	125	(3)
	250	...	(3)
Steel	150	(4)	(3)	...	+0.50	+0.50	(5)	+0.38	+0.38
	300	(4)	(3)	...	+0.50	+0.50	(5)	+0.38	+0.38
	600 to 2500	(3)	(6)	(6)	(5)	-0.12	-0.12

GENERAL NOTE: Dimensions are in inches.

NOTES:

- (1) To determine the face-to-face or end-to-end dimensions of valves having both flanges as tabulated in this table, adjust the face-to-face (*not* the butt-weld end-to-end) dimensions shown for the valve type (gate, globe, etc.), material, class, and size in Tables I-1 through I-6 by the amount shown.
- (2) For center-to-face or center-to-end dimensions of angle type valves, use one-half the numerical adjustment shown herein.
- (3) These face-to-face dimensions are listed in Tables I-1 through I-7. (See table of desired class.)
- (4) For Class 150 and for Class 300 steel valves having flat faces, either the full thickness of the flange or the thickness with the 0.06 in. raised face removed may be supplied unless otherwise specified. For full thickness of flange, the face-to-face dimensions listed for 0.06 in. raised face apply. Users are reminded that removing the 0.06 in. raised faces will make the face-to-face dimensions nonstandard.
- (5) The *X* dimensions given in Table I-10 added to the appropriate raised face flange face-to-face dimensions of Tables I-1 through I-6 establish the end-to-end dimensions of steel valves having flanges with ring joint facings.
- (6) These face-to-face dimensions are those listed for 0.25 in. raised face in Tables I-3 through I-6.

Table I-10 Classes 150 to 2500 Steel Valves Having End Flanges With Ring Joint Facings, End-to-End Dimensions

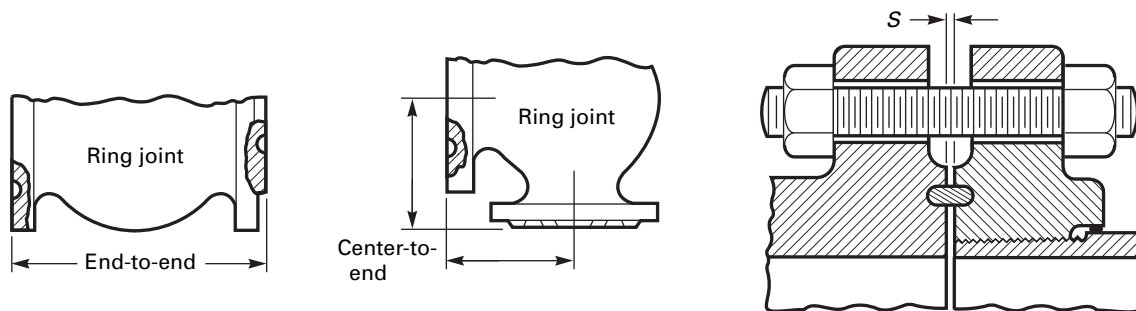

Nominal Valve Size		1	2	3	4	5	6	7	8	9	10	11	12
		Class 150		Class 300		Class 600		Class 900		Class 1500		Class 2500	
NPS	DN	X	S	X	S	X	S	X	S	X	S	X	S
1/2	15	0.44	0.12	-0.06 (1)	0.12	0	0.16	0	0.16	0	0.16
3/4	20	0.50	0.16	0	0.16	0	0.16	0	0.16	0	0.16
1	25	0.50	0.16	0.50	0.16	0	0.16	0	0.16	0	0.16	0	0.16
1 1/4	32	0.50	0.16	0.50	0.16	0	0.16	0	0.16	0	0.16	0.12	0.12
1 1/2	40	0.50	0.16	0.50	0.16	0	0.16	0	0.16	0	0.16	0.12	0.12
2	50	0.50	0.16	0.62	0.22	0.12	0.19	0.12	0.12	0.12	0.12	0.12	0.12
2 1/2	65	0.50	0.16	0.62	0.22	0.12	0.19	0.12	0.12	0.12	0.12	0.25	0.12
3	80	0.50	0.16	0.62	0.22	0.12	0.19	0.12	0.16	0.12	0.12	0.25	0.12
4	100	0.50	0.16	0.62	0.22	0.12	0.19	0.12	0.16	0.12	0.12	0.38	0.16
5	125	0.50	0.16	0.62	0.22	0.12	0.19	0.12	0.16	0.12	0.12	0.50	0.16
6	150	0.50	0.16	0.62	0.22	0.12	0.19	0.12	0.16	0.25	0.12	0.50	0.16
8	200	0.50	0.16	0.62	0.22	0.12	0.19	0.12	0.16	0.38	0.16	0.62	0.19
10	250	0.50	0.16	0.62	0.22	0.12	0.19	0.12	0.16	0.38	0.16	0.88	0.25
12	300	0.50	0.16	0.62	0.22	0.12	0.19	0.12	0.16	0.62	0.19	0.88	0.31
14	350	0.50	0.12	0.62	0.22	0.12	0.19	0.38	0.16	0.75	0.22
16	400	0.50	0.12	0.62	0.22	0.12	0.19	0.38	0.16	0.88	0.31
18	450	0.50	0.12	0.62	0.22	0.12	0.19	0.50	0.19	0.88	0.31
20	500	0.50	0.12	0.75	0.22	0.25	0.19	0.50	0.19	0.88	0.38
22	550	0.50 (2)	(3)	0.88 (2)	0.25	0.38 (2)	0.22
24	600	0.50	0.12	0.88	0.25	0.38	0.22	0.75	0.22	1.12	0.44

Table I-10 Classes 150 to 2500 Steel Valves Having End Flanges With Ring Joint Facings, End-to-End Dimensions (Cont'd)

Nominal Valve Size		1	2	3	4	5	6	7	8	9	10	11	12
		Class 150		Class 300		Class 600		Class 900		Class 1500		Class 2500	
NPS	DN	X	S	X	S	X	S	X	S	X	S	X	S
26	650	1.00 (2)	0.25	0.50 (2)	0.22	0.87	(3)
28	700	1.00 (2)	0.25	0.50 (2)	0.22	0.87	(3)
30	750	1.00 (2)	0.25	0.50 (2)	0.22	0.87	(3)
32	800	1.12 (2)	(3)	0.62 (2)	(3)	0.87	(3)
34	850	1.12 (2)	(3)	0.62 (2)	(3)	1.12	(3)
36	900	1.12 (2)	(3)	0.62 (2)	(3)	1.12	(3)

GENERAL NOTES:

- (a) Dimensions are in inches.
- (b) Flanges conform to those of ASME B16.5 for the corresponding size and pressure class, except in NPS 22, NPS 26, and larger sizes. See Note (2).
- (c) To determine the end-to-end dimensions of valves having flanges with ring joint facings, the X dimensions must be added to the nominal raised face flange face-to-face dimensions of Tables I-1 through I-6. For angle and angle lift check valves, one-half of the X dimensions as listed in this table must be added to the nominal dimensions for center-to-end dimensions. For approximate distance between ends of flanges having octagonal or oval ring gaskets, when rings are compressed, use S dimensions as listed in this table.

NOTES:

- (1) This dimension has a minus value because the height of the applicable ring joint face is 0.22 in., whereas the height of the raised face is 0.25 in.
- (2) Flanges for NPS 22, NPS 26, and larger sizes conform to those of MSS SP-44 and ASME B16.47, Series A for the corresponding size and pressure class.
- (3) S dimension is not determined.

NONMANDATORY APPENDIX A REFERENCES

The following is a list of publications referenced in this Standard.

API 6D, Twenty-Fourth Edition, Specification for Pipeline Valves

API 594, Eighth Edition, Check Valves: Flanged, Lug, Wafer, and Butt-Welding

API 609, Seventh Edition, Butterfly Valves: Double-Flanged, Lug- and Wafer-Type

Publisher: American Petroleum Institute (API), 1220 L Street, NW, Washington, DC 20005 (www.api.org)

ASME B16.1, Cast Iron Pipe Flanges and Flanged Fittings, Class 25, 125, 250, and 800

ASME B16.5, Pipe Flanges and Flanged Fittings

ASME B16.24, Cast Copper Alloy Pipe Flanges and Flanged Fittings, Class 150, 300, 400, 600, 900, 1500, and 2500

ASME B16.34, Valves — Flanged, Threaded, and Welding End

ASME B16.42, Ductile Iron Pipe Flanges and Flanged Fittings, Class 150 and 300

ASME B16.47, Large Diameter Steel Flanges NPS 26 through NPS 60

Publisher: The American Society of Mechanical Engineers (ASME), Two Park Avenue, New York, NY 10016 (www.asme.org)

AWWA C207-13, Steel Pipe Flanges for Waterworks Service, Sizes 4 In. Through 144 In. (100 mm Through 3600 mm)

AWWA C508-09, Swing-Check Valves for Waterworks Service, 2-In. Through 24-In. (50-mm Through 600-mm) NPS

AWWA C517-09, Resilient-Seated Cast-Iron Eccentric Plug Valves

Publisher: American Water Works Association (AWWA), 6666 W. Quincy Avenue, Denver, CO 80235 (www.awwa.org)

MSS SP-44-2010, Steel Pipe Line Flanges

MSS SP-67-2011, Butterfly Valves

MSS SP-68-2011, High Pressure Butterfly Valves with Offset Design

MSS SP-81-2013, Stainless Steel Bonnetless, Flanged Knife Gate Valves

MSS SP-135-2006, High Pressure Steel Knife Gate Valves

Publisher: Manufacturers Standardization Society of the Valve and Fittings Industry (MSS), 127 Park Street, NE, Vienna, VA 22180 (www.mss-hq.org)

Publications appearing above that have been approved as American National Standards may also be obtained from the American National Standards Institute (ANSI), 25 West 43rd Street, New York, NY 10036.

ASME B16.10-2017

ISBN 978-0-7918-7147-8



9 7 8 0 7 9 1 8 7 1 4 7 8



J 0 3 1 1 7